

UKパンチングシリーズ

ステンレス製パンチング板

金網製の煮籠のように針金が折損して、煮炊物の中に入り込む心配はありません。耐久力抜群にて、錆びに強く衛生的です。



パンチングシリーズのパンチ材は網に比べ、

- 針金が折れて食べ物に入り込む心配が無い
- ほつれが無い
- 目詰まりしにくい
- 水切れが良く洗いやすい
- 錆びに強く衛生的
- 耐久力抜群

パンチングシリーズは、丸穴7種類と角穴11種類の穴径の材質を使い、それぞれの用途に適した材料を選定して商品を開発しています。



1.1φ2P

【標準仕様穴径】1.1mm 2ピッチ
【材質】SUS-304
(18-8Stainless steel)
※板厚は0.5mmにのみ対応します。



1.5φ3P

【標準仕様穴径】1.5mm 3ピッチ
【材質】SUS-304
(18-8Stainless steel)

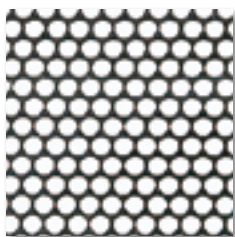

2.2φ4P

【標準仕様穴径】2.2mm 4ピッチ
【材質】SUS-304
(18-8Stainless steel)



3φ4P

【標準仕様穴径】3.0mm 4ピッチ
【材質】SUS-304
(18-8Stainless steel)

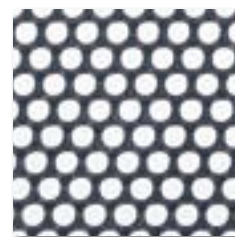

3φ5P

【標準仕様穴径】3.0mm 5ピッチ
【材質】SUS-304
(18-8Stainless steel)
※特注扱いです

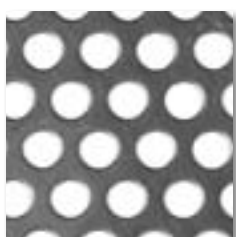

5φ8P

【標準仕様穴径】5.0mm 8ピッチ
【材質】SUS-304
(18-8Stainless steel)
※特注扱いです

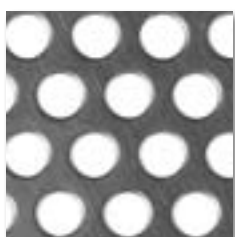

6φ9P

【標準仕様穴径】6.0mm 9ピッチ
【材質】SUS-304
(18-8Stainless steel)
※特注扱いです

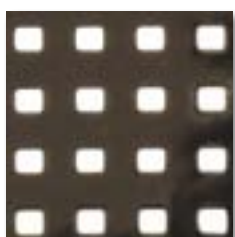

角穴 3×3mm

【標準仕様穴径】3.0×3.0mm
【材質】SUS-304
(18-8Stainless steel)

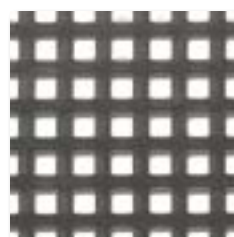

角穴 3.5×3.5mm

【標準仕様穴径】3.5×3.5mm
【材質】SUS-304
(18-8Stainless steel)

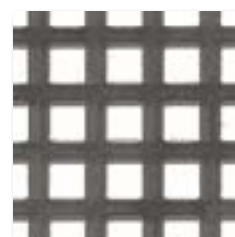

角穴 5×5mm

【標準仕様穴径】5.0×5.0mm
【材質】SUS-304
(18-8Stainless steel)

特注でさまざまなご要望にお応えいたします



■手差しハンドルもできます



■ハンドルも特注できます



■角穴タイプもできます



揚げザルに
限ります

■穴の大きさも
変えられます

揚げザルに
限ります



※製造上、目の形、大きさが異なる場合があります。
※表示以外の目の大きさについては、ご相談ください。

※特注で、目の大きさは変更できます。
※ピッチとは、穴の中心から穴の中心の距離です。



角穴 10×10mm

【標準仕様穴径】10.0×10.0mm
【材質】SUS-304
(18-8Stainless steel)



長角穴 3×30mm

【標準仕様穴径】3.0×30.0mm
【材質】SUS-304
(18-8Stainless steel)



長角穴 6×10mm

【標準仕様穴径】6.0×10.0mm
【材質】SUS-304
(18-8Stainless steel)



長角穴 6×15mm

【標準仕様穴径】6.0×15.0mm
【材質】SUS-304
(18-8Stainless steel)



長角穴 6×30mm

【標準仕様穴径】6.0×30.0mm
【材質】SUS-304
(18-8Stainless steel)



長角穴 4×35mm

【標準仕様穴径】4.0×35.0mm
【材質】SUS-304
(18-8Stainless steel)



角穴 20×20mm

【標準仕様穴径】20.0×20.0mm
【材質】SUS-304
(18-8Stainless steel)



長角穴 6×80mm

【標準仕様穴径】6.0×80.0mm
【材質】SUS-304
(18-8Stainless steel)

PUNCHING SERIES (ST.ST)



COLANDER/W/PROTECTION
揚げザル/横ビード補強入

0990 7400	42 cm	¥37,400	¥39,600
●42φ×H31 (cm)			
0990 7401	45	¥38,500	¥40,700
●45φ×H31			
0990 7402	48	¥39,600	¥41,800
●48φ×H31			
0990 7403	51	¥41,800 (5.0φ)	¥44,000 (2.2φ)
●0.7t (5.0φ)			



COLANDER/W/PROTECTION
揚げザル/縦ビード補強入

0990 7410	42 cm	¥37,400	¥39,600
●42φ×H31 (cm)			
0990 7411	45	¥38,500	¥40,700
●45φ×H31			
0990 7412	48	¥39,600	¥41,800
●48φ×H31			
0990 7413	51	¥41,800 (5.0φ)	¥44,000 (2.2φ)
●0.7t (5.0φ)			



COLANDER/W/PROTECTION
揚げザル/深型(補強付)

0990 7482	42 cm	¥38,500	¥40,700
●42φ×H31 (cm)			
0990 7485	45	¥39,600	¥41,800
●45φ×H31			
0990 7488	48	¥40,700	¥42,900
●48φ×H31			
0990 7491	51	¥42,900 (5.0φ)	¥45,100 (2.2φ)
●0.7t (5.0φ)			



COLANDER
揚げザル/深型

0990 7442	42 cm	¥35,200	¥36,500	¥37,400
●42φ×H31 (cm)				
0990 7445	45	¥36,300	¥37,500	¥38,500
●45φ×H31				
0990 7448	48	¥37,400	¥38,500	¥39,600
●48φ×H31				
0990 7451	51	¥40,700 (5.0φ)	¥41,800 (3.0φ)	¥42,900 (2.2φ)
●0.7t (5.0φ)				



COLANDER/W/PROTECTION
揚げザル/深型(補強付)

0990 7520	42 cm	¥41,300
●42φ×H31 (cm)		
0990 7521	45	¥42,400
●45φ×H31		
0990 7522	48	¥43,500
●48φ×H31		
0990 7523	51	¥45,700
●51φ×H31		
●0.7t 10φ 20P		



COLANDER
揚げザル/深型 バイブハンドル

0990 7540	42 cm	¥38,500	¥40,700
●42φ×H31 (cm)			
0990 7541	45	¥39,600	¥41,800
●45φ×H31			
0990 7542	48	¥40,700	¥42,900
●48φ×H31			
0990 7543	51	¥44,000 (5.0φ)	¥46,200 (2.2φ)
●0.7t (5.0φ)			



COLANDER
揚げザル/深型(手差しハンドル)

0990 7420	42 cm	¥44,000
●42φ×H31 (cm)		
0990 7421	45	¥45,100
●45φ×H31		
0990 7422	48	¥47,300
●48φ×H31		
0990 7423	51	¥49,500
●51φ×H31		
●0.7t 3.5×3.5角穴		





COLANDER
揚げザル/平底

0990 7245	45 cm	¥33,000	¥33,500	¥34,100
●45φ×H17.5(cm)				
0990 7248	48	¥34,200	¥34,700	¥35,200
●48φ×H18				
0990 7251	51	¥36,500	¥37,000	¥37,400
●51φ×H19.5				
0990 7255	55	¥44,100	¥44,600	¥45,100
●55φ×H20				
0990 7260	60	¥49,600	¥50,100	¥50,600
●60φ×H22				
0990 7265	65	¥55,100	¥55,600	¥56,100
●65φ×H23				
●0.7t (2.2φ)				
*特注サイズもできます				



COLANDER/W/PROTECTION
揚げザル/平底(補強付)

0990 7275	45 cm	¥34,200	¥34,700	¥35,200
●45φ×H17.5(cm)				
0990 7278	48	¥35,300	¥35,800	¥36,300
●48φ×H18				
0990 7281	51	¥38,600	¥39,100	¥39,600
●51φ×H19.5				
0990 7285	55	¥46,300	¥46,800	¥47,300
●55φ×H20				
0990 7290	60	¥50,700	¥51,200	¥51,700
●60φ×H22				
0990 7295	65	¥56,200	¥56,700	¥57,200
●65φ×H23				
●0.7t (2.2φ)				
*特注サイズもできます				



COLANDER
揚げザル/平底 パイプハンドル

0990 7370	45 cm	¥33,000
●45φ×H17.5(cm)		
0990 7371	48	¥36,300
●48φ×H18		
0990 7372	51	¥37,400
●51φ×H19.5		
0990 7373	55	¥45,100
●55φ×H20		
0990 7374	60	¥50,600
●60φ×H22		
0990 7375	65	¥56,100
●65φ×H23		
●0.7t 10φ 15P		
*特注サイズもできます		



COLANDER
揚げザル/平底

0990 7320	45 cm	¥40,700
●45φ×H17.5(cm)		
0990 7321	48	¥41,800
●48φ×H18		
0990 7322	51	¥46,200
●51φ×H19.5		
0990 7323	55	¥51,700
●55φ×H20		
0990 7324	60	¥57,200
●60φ×H22		
0990 7325	65	¥62,700
●65φ×H23		
●0.7t 3.5×3.5角穴		
*特注サイズもできます		



*特注で固定式
ハンドルもできます。

COLANDER
揚げザル/底バンチング

0990 7340	45 cm	¥35,800
●45φ×H17.5(cm)		
0990 7341	48	¥36,900
●48φ×H18		
0990 7342	51	¥39,100
●51φ×H19.5		
0990 7343	55	¥46,200
●55φ×H20		
0990 7344	60	¥50,600
●60φ×H22		
0990 7345	65	¥56,100
●65φ×H23		
●0.7t 2.2φ		
*特注品		
●SPECIAL ORDER		



SPINNER
遠心脱水ざる(ハンドル付)

0990 7590 ¥89,500
●外46φ×内45φ×H31(cm)
●特注品
●SPECIAL ORDER



SPINNER
遠心脱水ざる(ハンドルなし)/角淵

0990 7580 ¥83,000
●外50φ×内45φ×H27(cm)
●特注品
●SPECIAL ORDER



SPINNER
遠心脱水ざる(ハンドルなし)/R淵

0990 7581 ¥83,000
●外50φ×内45φ×H27(cm)
●特注品
●SPECIAL ORDER

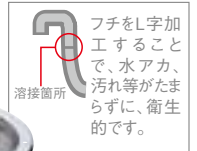
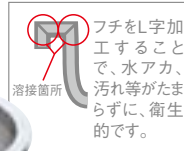

COLANDER/W/PROTECTION
揚げザル/深・深型(補強付)

0990 7531 45 cm ¥61,800
●45φ×H50(cm)
0990 7532 48 ¥64,300
●48φ×H50
0990 7533 51 ¥69,000
●51φ×H50
●0.8t 3.0φ 5P



COLANDER/SQUARE
揚げザル/角型

0990 7210 33 cm ¥31,600
●33×33×H14(cm)
0990 7211 37 ¥40,600
●37.5×37.5×H16.5
0990 7212 43 ¥48,300
●43×43×H18.7
●0.7t 2.2φ



DOLLY
ドローリー

0990 9900 -650 ¥75,000
0990 9902 -510 ¥69,000
0990 9904 -400 ¥66,000
●18-8 キャスター使用
●揚げザル/深型は別売です。

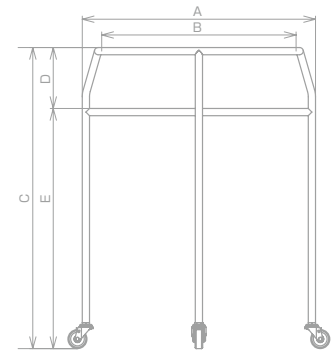

	A 外径(mm)	B 上枠内径(mm)	C 全高(mm)	D 中受深さ(mm)	E 中受高さ(mm)
0990 9900	750	650	810	140	670
0990 9902	610	510	810	140	670
0990 9904	500	400	810	140	670

●キャスター SUS304
●50φ×4/自在 ストッパー付×2 ストッパー無×2



COLANDER
水切りザル

0990 4818	18 cm	¥5,950
●19.5φ×H7.5(cm)	●0.23(kg)	
0990 4821	21	¥6,500
●22.5φ×H8.5	●0.30	
0990 4824	24	¥7,500
●25.5φ×H9.5	●0.38	
0990 4827	27	¥9,460
●28.5φ×H11	●0.48	
0990 4830	30	¥10,900
●32.0φ×H12.5	●0.56	
●0.6t 2.2φ		



COLOR PLATE
コランダ-用 カラープレート

0990 4000	ピンク	¥1,480
0990 4001	ブルー	¥1,480
0990 4002	イエロー	¥1,480
0990 4003	グリーン	¥1,480
●12×1.5(cm)		



COLANDER
浅型ザル

●OPTIONAL ハンドル付

0990 7033	33 cm	¥14,900
●35.5φ×H14(cm)	●0.78(kg)	
0990 7035	35	¥17,100
●37.5φ×H15.5	●0.86	
0990 7037	37.5	¥19,800
●40.0φ×H16	●0.95	
0990 7040	40	¥22,600
●42.5φ×H17	●1.16	
0990 7043	43	¥24,800
●45.5φ×H17.5	●1.32	
0990 7046	46	¥28,000
●48.5φ×H19.5	●1.47	
0990 7050	50	¥32,800
●52.5φ×H21	●1.70	
0990 7055	55	¥42,000
●57.5φ×H21	●2.05	
0990 7060	60	¥46,000
●62.5φ×H22	●2.65	
0990 7065	65	¥49,800
●67.5φ×H22	●2.92	
●0.7t 2.2φ		



●OPTIONAL パイプハンドル

COLANDER
浅型ザル/手付(可動式)

0990 7010	40 cm	¥27,600
●42.5φ×H17(cm)	●1.46(kg)	
0990 7013	43	¥29,300
●45.5φ×H17.5	●1.58	
0990 7016	46	¥32,800
●48.5φ×H19.5	●1.75	
0990 7020	50	¥37,400
●52.5φ×H21	●1.97	
0990 7025	55	¥46,600
●57.5φ×H21	●2.39	
●0.7t 2.2φ		



●OPTIONAL ハンドル付

COLANDER
深型ザル

0990 7127	27.5 cm	¥16,000
●30.0φ×H16.5(cm)	●容量:3升 ●0.69(kg)	
0990 7130	30	¥17,800
●32.5φ×H18	●容量:4 ●0.82	
0990 7133	33	¥20,100
●35.5φ×H20	●容量:5 ●1.05	
0990 7135	35	¥25,300
●37.5φ×H21.5	●容量:8 ●1.17	
0990 7137	37.5	¥28,900
●40.0φ×H23	●容量:10 ●1.29	
●0.7t 2.2φ		



COLANDER
米揚げザル

0990 7227	27.5 cm	¥18,000
●30.0φ×H16.5(cm)	●容量:3升 ●0.65(kg)	
0990 7230	30	¥19,300
●32.5φ×H18	●容量:4 ●0.80	
0990 7233	33	¥20,000
●35.5φ×H20	●容量:5 ●0.96	
0990 7235	35	¥28,000
●37.5φ×H21.5	●容量:8 ●1.07	
0990 7237	37.5	¥30,500
●40.0φ×H23	●容量:10 ●1.23	
●0.7t 1.5φ		





COLANDER
手付浅型ザル

0990 6933	33 cm	¥ 23,000
● 35.5 φ × H13 (cm)		
0990 6935	35	¥ 24,000
● 37.5 φ × H13.5		
0990 6937	37.5	¥ 25,300
● 40.0 φ × H15		
0990 6940	40	¥ 27,600
● 42.5 φ × H16.5		
0990 6943	43	¥ 31,000
● 45.5 φ × H18		
0990 6946	46	¥ 32,200
● 48.5 φ × H20		
0990 6950	50	¥ 37,000
● 52.5 φ × H22		
0990 6955	55	¥ 45,000
● 57.5 φ × H22.5		
0990 6960	60	¥ 49,500
● 62.5 φ × H23		
0990 6965	65	¥ 53,000
● 67.0 φ × H28		
● 0.8t 脇3φ穴 底4φ穴		



● OPTIONAL ハンドル付

COLANDER
巾広浅型ザル

0990 7073	33 cm	¥ 16,100
● 35.5 φ × H14 (cm)		
0990 7075	35	¥ 19,600
● 37.5 φ × H15.5		
0990 7077	37.5	¥ 23,000
● 40.0 φ × H16		
● 0.7t 2.2φ		
0990 7080	40	¥ 25,300
● 42.5 φ × H17		
0990 7083	43	¥ 27,600
● 45.5 φ × H17.5		
0990 7086	46	¥ 31,000
● 48.5 φ × H19.5		
0990 7090	50	¥ 35,700
● 52.5 φ × H21		
0990 7095	55	¥ 44,900
● 57.5 φ × H21		
0990 7100	60	¥ 47,100
● 62.5 φ × H22		
0990 7105	65	¥ 51,700
● 67.5 φ × H22		
● 0.8t 2.2φ		



(0.5t 1.5φ)



(0.8t 2.2φ)

COLANDER
揚げザル

0990 6124	24 cm	¥ 5,600
● 26 φ × H7 (cm)		
0990 6126	26	¥ 6,350
● 28 φ × H7.5		
0990 6128	28	¥ 7,000
● 30 φ × H8		
0990 6130	30	¥ 7,560
● 32 φ × H8.5		
0990 6133	33	¥ 9,200
● 35 φ × H9		
● 0.5t 1.5φ		
0990 6143	43	¥ 19,800
● 43 φ × H14.5		
0990 6146	46	¥ 27,200
● 46 φ × H14.5		
0990 6150	50	¥ 33,500
● 50 φ × H14.5		
● 0.8t 2.2φ		



(0.5t 1.5φ)



(0.8t 2.2φ)

COLANDER
ためザル

0990 6024	24 cm	¥ 5,260
● 26 φ × H1.7 (cm)		
0990 6026	26	¥ 5,850
● 28 φ × H1.9		
0990 6028	28	¥ 6,400
● 30 φ × H2		
0990 6030	30	¥ 7,360
● 32 φ × H2.2		
0990 6033	33	¥ 8,850
● 35 φ × H2.4		
● 0.5t 1.5φ		
0990 6043	43	¥ 17,900
● 46 φ × H5.5		
0990 6046	46	¥ 19,000
● 49 φ × H5.5		
0990 6050	50	¥ 22,500
● 53 φ × H5.5		
● 0.8t 2.2φ		





COLANDER/W/HANDLES
手付パンチボール(手付ボールザル/深型)

0990 4115	15 cm	¥4,400
● 16φ × H6.5 (cm)		
0990 4118	18	¥4,850
● 20φ × H7		
0990 4121	21	¥5,850
● 23φ × H8.5		
0990 4124	24	¥7,600
● 26φ × H9.5		
0990 4127	27	¥9,750
● 29φ × H10		
0990 4130	30	¥12,100
● 32φ × H11.5		
● 0.6t 1.2φ		
● サイズはハンドルを含んでおりません。		



COLANDER/ROUND/DEEP
深型パンチボール(ボールザル/深型)

0990 4015	15 cm	¥2,800
● 16φ × H6.5 (cm)		
0990 4018	18	¥3,450
● 20φ × H7		
0990 4021	21	¥4,300
● 23φ × H8.5		
0990 4024	24	¥5,600
● 26φ × H9.5		
0990 4027	27	¥7,950
● 29φ × H10		
0990 4030	30	¥9,800
● 32φ × H11.5		
● 0.6t 1.2φ		



COLANDER/ROUND/SHALLOW
浅型パンチボール(ボールザル/浅型)

0990 4515	15 cm	¥2,450
● 16φ × H4.7 (cm)		
0990 4518	18	¥2,900
● 20φ × H5.5		
0990 4521	21	¥3,750
● 23φ × H6.3		
0990 4524	24	¥4,900
● 26φ × H6.7		
0990 4527	27	¥7,000
● 29φ × H7.5		
0990 4530	30	¥8,750
● 32φ × H8.3		
● 0.6t 1.2φ		



COLANDER/ROUND
パンチング盆ザルボール(盆ザル)

0990 4615	15 cm	¥2,200
● 16φ × H3.4 (cm)		
0990 4618	18	¥2,690
● 20φ × H3.4		
0990 4621	21	¥3,300
● 23φ × H3.4		
0990 4624	24	¥4,260
● 26φ × H3.4		
0990 4627	27	¥6,200
● 29φ × H3.4		
0990 4630	30	¥7,600
● 32φ × H3.4		
● 0.5t 1.5φ		



COLANDER/ROUND
パンチングそばザル(浅型盆ザル)

0990 4715	15 cm	¥1,930
● 16φ × H1.8 (cm)		
0990 4718	18	¥2,420
● 20φ × H1.8		
0990 4721	21	¥2,950
● 23φ × H1.8		
0990 4724	24	¥3,750
● 26φ × H1.8		
0990 4727	27	¥5,500
● 29φ × H1.8		
0990 4730	30	¥6,600
● 32φ × H1.8		
● 0.5t 1.5φ		

HACCP対応食品衛生 対象商品



HACCPとは

HACCP(ハサップ)は、米国航空宇宙局(NASA)が宇宙食の製造にあたって食品の安全性を確実に保証できる衛生管理手法として開発した方法です。食品の安全性を確保する上で最も効果的な手法であるとして、世界的にも高く評価され、すでに多くの国で導入されています。



COLANDER
HACCP 水切りボール

電解
仕上

0990 5118	18 cm	¥5,450
●20φ×H7(cm)		
0990 5121	21	¥6,150
●23φ×H8		
0990 5124	24	¥7,350
●26.5φ×H9		
0990 5127	27	¥9,400
●29.5φ×H10		
0990 5130	30	¥11,000
●33φ×H11		
●0.6t 2.2φ		



COLANDER
HACCP 浅型ザル

0990 6980	33 cm	¥15,500
●35.5φ×H12(cm)		
0990 6982	35	¥17,600
●37.5φ×H13.5		
0990 6984	37.5	¥19,800
●40.0φ×H14		
●0.7t 2.2φ		
0990 6986	40	¥23,100
●42.5φ×H15		
0990 6988	43	¥25,500
●45.5φ×H15.5		
0990 6990	46	¥28,600
●48.5φ×H17.5		
0990 6992	50	¥33,000
●52.5φ×H19		
0990 6994	55	¥42,000
●57.5φ×H19		
0990 6996	60	¥45,000
●62.5φ×H20		
0990 6998	65	¥49,500
●67.5φ×H20		
●0.8t 2.2φ		



COLANDER/ROUND/DEEP

HACCP 深型パンチボール(ボールザル/深型)		
0990 4050	15 cm	¥3,100
●16φ×H6.5(cm)		
0990 4052	18	¥3,650
●20φ×H7		
0990 4054	21	¥4,650
●23φ×H8.5		
0990 4056	24	¥5,850
●26φ×H9.5		
0990 4058	27	¥8,150
●29φ×H10		
0990 4060	30	¥10,300
●32φ×H11.5		
●0.6t 1.2φ		



COLANDER/ROUND/SHALLOW

HACCP 浅型パンチボール(ボールザル/浅型)		
0990 4550	15 cm	¥2,700
●16φ×H4.7(cm)		
0990 4552	18	¥3,150
●20φ×H5.5		
0990 4554	21	¥4,100
●23φ×H6.3		
0990 4556	24	¥5,200
●26φ×H6.7		
0990 4558	27	¥7,200
●29φ×H7.5		
0990 4560	30	¥8,900
●32φ×H8.3		
●0.6t 1.2φ		



COLANDER/ROUND

HACCP パンチング盆ザルボール(盆ザル)		
0990 4650	15 cm	¥2,400
●16φ×H3.4(cm)		
0990 4652	18	¥2,900
●20φ×H3.4		
0990 4654	21	¥3,550
●23φ×H3.4		
0990 4656	24	¥4,500
●26φ×H3.4		
0990 4658	27	¥6,300
●29φ×H3.4		
0990 4660	30	¥7,650
●32φ×H3.4		
●0.5t 1.5φ		



COLANDER/ROUND

HACCP パンチングそばザル(浅型盆ザル)		
0990 4750	15 cm	¥2,200
●16φ×H1.8(cm)		
0990 4752	18	¥2,700
●20φ×H1.8		
0990 4754	21	¥3,200
●23φ×H1.8		
0990 4756	24	¥4,100
●26φ×H1.8		
0990 4758	27	¥5,750
●29φ×H1.8		
0990 4760	30	¥6,950
●32φ×H1.8		
●0.5t 1.5φ		



COLANDER
HACCP 深型ザル

0990 7150	27.5 cm	¥16,500
●30.0φ×H14.8(cm) ●容量:3升		
0990 7152	30	¥17,600
●32.5φ×H16.3 ●容量:4		
0990 7154	33	¥19,800
●35.5φ×H18 ●容量:5		
0990 7156	35	¥25,300
●37.5φ×H19.5 ●容量:8		
0990 7158	37.5	¥28,600
●40.0φ×H21 ●容量:10		
●0.8t 2.2φ		



COLANDER for STOCK POT
スープ取りザル

0926 3036	36 cm	¥47,500
●35φ×H35 (cm)		
0926 3039	39	¥50,600
●38φ×H38		
0926 3042	42	¥60,500
●41φ×H41		
0926 3045	45	¥67,500
●44φ×H44		
0926 3048	48	¥77,000
●47φ×H47		
●0.7t 2.2φ		

*48cmは受注生産です。
*特注サイズも出来ます。



COLANDER for STOCK POT
半丸スープ取りザル

0926 3136	36 cm	¥33,000
●35φ×18×H30 (cm)		
0926 3139	39	¥35,200
●38φ×20×H33		
0926 3142	42	¥39,700
●41φ×21×H36		
0926 3145	45	¥46,300
●44φ×23×H39		
0926 3148	48	¥47,400
●47φ×25×H42		
●0.7t 2.2φ		

*48cmは受注生産です。
*特注サイズも出来ます。



COLANDER
蒸しザル(手付)

0990 7350	50 cm	¥54,800
●50φ×H10 (cm)		
0990 7360	60	¥65,000
●60φ×H10		
●0.7t 2.2φ		

*特注サイズも出来ます。



COLANDER
蒸しザル(手付)

0990 7365	¥109,000
●74φ×64φ×H18 (cm)	
●0.8t 6φ15P	



COLANDER
丸スープ取りザル

0926 3000	¥32,800
●20φ×H29.5 (cm)	
●0.6t 1.5φ	



SPAGHETTI BASKET
スパゲッティカゴ

0925 3075	¥42,800
●27.5φ×H29 (cm)	
●0.5t 1.5φ3P	





ROUND FRYER/W/HANDLS
丸フライヤー/ハンドル付

0925 3710 —26 cm	¥9,800
●26φ (cm)	
0925 3720 —28	¥10,400
●28φ	
0925 3730 —30	¥11,100
●30φ	
0925 3740 —33	¥12,100
●33φ	
●0.6t 1.5φ	



ROUND FRYER/W/HANDLS
丸フライヤー/かす揚げ(ハンドル付)

0925 3810 —26 cm	¥8,700
●26φ (cm)	
0925 3820 —28	¥9,000
●28φ	
0925 3830 —30	¥9,700
●30φ	
●0.6t 3.0φ	



丸キッチンポットと組合せて
使用出来ます。



丸キッチンポットと組合せて
使用出来ます。



BOIL-BASKET/Double Handles
ボイルバスケット/両手ハンドル

0925 3122 21cm	¥13,500
●21φ×H18 (cm)	
0925 3125 24	¥15,600
●24φ×H21	
●0.5t 1.5φ	
*特注サイズも出来ます。	



BOIL-BASKET/Singl Handle
ボイルバスケット/片手ハンドル

0925 3115 15 cm	¥9,500
●15φ×H11 (cm)	
0925 3118 18	¥10,500
●18φ×H13	
0925 3121 21	¥13,300
●21φ×H15	
0925 3124 24	¥13,900
●24φ×H16	
●0.5t 1.5φ	
*特注サイズも出来ます。	



BOIL-BASKET
スパゲッティストレーナー

0925 3180	¥16,000
●25φ×H12 (cm)	
handle:25 (cm) 0.6t 1.5φ	



COLANDER for STOCK BASKET
スープ取りカゴ

0926 3090 36 cm	¥82,500
●36φ×H36 (cm)	
0926 3091 57	¥149,000
●57φ×H27	
●0.7t 2.2φ	
*特注品(小豆・大豆煮豆カゴ)	
●SPECIAL ORDER	



COLANDER for STOCK BASKET
スープ取りカゴ

0926 3095 50cm	¥153,000
●50φ×H33.5 (cm)	
*特注品	
●SPECIAL ORDER	





FRYER
ポテトフライヤー

0925 3205-S ¥14,500
●28.5×12.5×H11 (cm) 0.7t 2.2φ
*特注サイズも出来ます。



FRYER
ポテトフライヤー

0925 3200-L ¥15,500
●28.5×17.5×H11 (cm) 0.7t 2.2φ
*特注サイズも出来ます。



BOIL-BASKET
パンチング フライドポテトバスケット

0925 3220 ¥14,700
●21×15×H15 (cm) 0.7t 5.0φ



BOIL-BASKET
パンチング スパゲッティバスケット

0925 3210 ¥19,700
●29×10×H15 (cm) 0.6t 1.5φ



BOIL-BASKET
冷凍麺とば

0925 3400-共柄 ¥11,000
0925 3410-パイプ柄 ¥13,000
●16×4.5×H14 (cm)
handle:17 (cm) 0.6t 2.2φ



FRYER
フライヤー

0925 3215 ¥21,000
●34×12.3×H12 (cm)
handle:30 (cm) 1.0t 6.0φ



BOIL-BASKET
パンチング フランクフルトバスケット

0925 3230 ¥13,200
●17φ×H17 (cm) 0.6t 5.0φ



STRAINER
こしてば

0925 3080 ¥8,300
●17φ×H11.5 (cm)
handle:24.5 (cm) 0.5t 1.1φ



STRAINER
みそこし

0925 3320 ¥1,950
●10φ×H6.5×23 (全高) (cm)
●1.8φ



STRAINER
こしてば/みそこし

0925 3310 ¥3,900
●12.5φ×H11.2×30 (全高) (cm)
●2.2φ

COLOR HANDLE STRAINER

カラーハンドル付てぼ



RED

BLUE

YELLOW

GREEN

COLOR HANDLE STRAINER

カラーハンドル付てぼ

L	●14φ×H18(cm)	¥5,900
S	●14φ×H13	¥5,500
●シリコンハンドル ●各色共通価格		

商品コード

SIZE	レッド	ブルー	イエロー	グリーン
L	0925 3151	0925 3152	0925 3153	0925 3154
S	0925 3141	0925 3142	0925 3143	0925 3144



木柄

共柄

パイプ柄

NOODLE STRAINER

てぼ / シリコンハンドル

0925 3150-L	¥5,650
●14φ×H18(cm)	
0925 3140-S	¥5,350
●14φ×H13	

NOODLE STRAINER

丸底うどんてぼ

0925 3040-L(木柄)	¥8,300	0925 3050-S(木柄)	¥7,850
0925 3041-L(共柄)	¥7,800	0925 3051-S(共柄)	¥7,700
0925 3042-L(パイプ柄)	¥10,300	0925 3052-S(パイプ柄)	¥9,850
●13.5φ×H17.5(cm)		●12.5φ×H16.5	
●handle:18.5(cm) 0.5t 2.2φ		●handle:18.5 0.5t 2.2φ	

NOODLE STRAINER

底平煮ざる / 一体成形



木柄

共柄

パイプ柄

シリコンハンドル

0925 3451-L(木柄)	¥6,160
0925 3452-L(共柄)	¥5,550
0925 3453-L(パイプ柄)	¥7,900
0925 3450-L(シリコンハンドル)	¥6,400
●17φ×H15.5(cm)	
0925 3461-M(木柄)	¥5,800
0925 3462-M(共柄)	¥5,200
0925 3463-M(パイプ柄)	¥7,600
0925 3460-M(シリコンハンドル)	¥6,100
●16.2φ×H14.5	
0925 3471-S(木柄)	¥5,400
0925 3472-S(共柄)	¥4,800
0925 3473-S(パイプ柄)	¥7,150
0925 3470-S(シリコンハンドル)	¥5,750
●15.2φ×H13.5	
●handle:18.5 0.5t 2.5φ6P	



SPAGHETTI STRAINER
スパゲッティてぼ

0925 3065-M(木柄) ¥9,800
0925 3067-M(パイプ柄) ¥11,200
●13.5φ×H18(cm)
handle:18.5(cm) 0.5t 1.5φ

SPAGHETTI STRAINER
スパゲッティてぼ

0925 3060-L(木柄) ¥10,700
0925 3062-L(パイプ柄) ¥12,100
●15.5φ×H22(cm)
handle:18.5(cm) 0.5t 1.5φ

SPAGHETTI STRAINER
スパゲッティてぼ

0925 3070-深型(木柄) ¥10,600
0925 3072-深型(パイプ柄) ¥11,900
●11.5φ×H30(cm)
handle:18.5(cm) 0.5t 1.5φ



NOODLE STRAINER
平底うどん揚げ

0925 3195-(木柄) ¥12,000
●18.7φ×H17(cm)
handle:18.5(cm) 0.5t 3.0φ



NOODLE STRAINER
平底うどん揚げ

0925 3196-(共柄) ¥11,800
●18.7φ×H17(cm)
handle:18.5(cm) 0.5t 3.0φ



NOODLE STRAINER
平底うどん揚げ

0925 3197-(パイプ柄) ¥13,000
●18.7φ×H17(cm)
handle:18.5(cm) 0.5t 3.0φ



●特注でシリコンハンドルもできます。

KITCHEN UTENSIL



木柄



共柄



パイプ柄

NOODLE STRAINER
深型底平煮ざるうどんてぼ

0925 3000-(木柄) ¥8,750
0925 3001-(共柄) ¥8,300
0925 3002-(パイプ柄) ¥11,200
●13φ×H20(cm)
handle:18.5(cm) 0.5t 2.2φ



木柄



共柄



パイプ柄

NOODLE STRAINER
底平煮ざる

0925 3010-L(木柄) ¥8,650
0925 3011-L(共柄) ¥8,200
0925 3012-L(パイプ柄) ¥10,800
●16.5φ×H16(cm)
0925 3020-M(木柄) ¥8,300
0925 3021-M(共柄) ¥7,600
0925 3022-M(パイプ柄) ¥10,000
●15φ×H15
0925 3030-S(木柄) ¥7,650
0925 3031-S(共柄) ¥7,250
0925 3032-S(パイプ柄) ¥9,500
●13.5φ×H14
●handle:18.5 0.5t 2.2φ
●特注で、シリコンハンドルもできます。



NOODLE STRAINER
角てぼ/縦型

0925 3100-L (木柄) ¥10,500
●18×11.5×H14 (cm)
handle:18.5 (cm) 0.7t 2.2φ

0925 3105-S (木柄) ¥9,100
●18×11.5×H8.5
handle:18.5 0.7t 2.2φ



NOODLE STRAINER
角てぼ/縦型

0925 3102-L (パイプ柄) ¥11,800
●18×11.5×H14 (cm)
handle:18.5 (cm) 0.7t 2.2φ

0925 3107-S (パイプ柄) ¥11,300
●18×11.5×H8.5
handle:18.5 0.7t 2.2φ



NOODLE STRAINER
角てぼ/横型

0925 3092-L (パイプ柄) ¥11,800
●18×11.5×H14 (cm)
handle:18.5 (cm) 0.7t 2.2φ

0925 3097-S (パイプ柄) ¥11,300
●18×11.5×H8.5
handle:18.5 0.7t 2.2φ



NOODLE STRAINER
角てぼ/横型

0925 3090-L (木柄) ¥10,500
●18×11.5×H14 (cm)
handle:18.5 (cm) 0.7t 2.2φ

0925 3095-S (木柄) ¥9,200
●18×11.5×H8.5
handle:18.5 0.7t 2.2φ



NOODLE STRAINER
角型うどん揚げ

0925 3190 (木柄) ¥13,800
●17.5×15.2×H13 (cm)
handle:18.5 (cm) 0.6t 2.2φ



NOODLE STRAINER
角型うどん揚げ

0925 3192 (パイプ柄) ¥14,800
●17.5×15.2×H13 (cm)
handle:18.5 (cm) 0.6t 2.2φ



NOODLE STRAINER
角型うどん揚げ

0925 3191 (共柄) ¥13,600
●17.5×15.2×H13 (cm)
handle:18.5 (cm) 0.6t 2.2φ



NOODLE STRAINER
そば揚げ/縦型

0990 6550 - 18 cm	¥8,150
●18φ (cm)	
0990 6551 - 21	¥8,600
●21φ	
0990 6552 - 24	¥9,900
●24φ	
●handle:36 (cm) 0.6t 3.0φ	



NOODLE STRAINER
そば揚げ/横型

0990 6560 - 18 cm	¥8,200
●18φ (cm)	
0990 6561 - 21	¥8,650
●21φ	
0990 6562 - 24	¥9,950
●24φ	
●handle:27 (cm) 0.6t 3.0φ	



OIL STRAINER
背油こし

0990 6570 - 21 cm	¥8,300
●21φ (cm)	
0990 6571 - 24	¥9,650
●24φ	
●handle:27 (cm) 0.6t 3.0φ	



OIL STRAINER
背油こし(丸かす揚げ)

0990 6581 - 20 cm	¥6,400
●20φ 全長:41 (cm)	
0990 6580 - 23	¥7,260
●23φ 全長:43.5	
●0.7t 2.2φ	



SKIMMER
角かす揚げ/板ハンドル

0925 3511-L	¥5,850
●18×22.5 (cm) 全長:70 (cm)	
0925 3521-M	¥4,950
●14×19 全長:57.5	
●0.7t 2.2φ	
0925 3531-S	¥4,300
●10×14 全長:43.5	
●0.6t 2.2φ	
●ツバ付できます。	



SKIMMER
角かす揚げ/パイプハンドル

0925 3510-L	¥7,600
●18×22.5 (cm) 全長:70 (cm)	
0925 3520-M	¥6,400
●14×19 全長:57.5	
●0.7t 2.2φ	



SQ SKIMMER
スクエア スキンマー

0925 3590	¥5,400
●15×15 (cm) 全長:45 (cm)	
●0.6t 2.2φ	



SKIMMER
丸かす揚げ/板ハンドル

0925 3611 23 cm	¥5,500
●23φ (cm)	
全長:67.5 (cm) handle:47.5 (cm)	
0925 3621 20	¥4,900
●20φ	
全長:59 handle:40	
0925 3631 17	¥4,300
●17φ	
全長:47 handle:31	
●0.7t 2.2φ	
●ツバ付できます。	



SKIMMER
丸かす揚げ/パイプハンドル

0925 3610 23 cm	¥7,260
●23φ (cm)	
全長:67.5 (cm) handle:47.5 (cm)	
0925 3620 20	¥6,400
●20φ	
全長:59 handle:40	
0925 3630 17	¥5,400
●17φ	
全長:47 handle:31	
●0.7t 2.2φ	



OIL STRAINER
角型油かす揚げ

0925 3550	¥17,500
●23×20×全長54 (cm)	



OIL STRAINER
角型油かす揚げ

0925 3560	¥18,900
●23×23×全長30 (cm)	
●0.5t 1.1φ 2P	



SKIMMER
角かす揚げ/ツバ付
特注品

KITCHEN UTENSIL

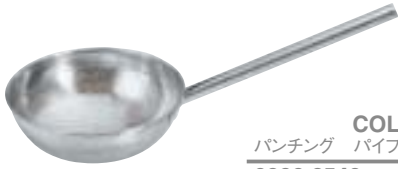

COLANDER
パンチング パイプ柄 丸型 スクイ玉揚
0990 6540 ¥13,600
●27φ (cm) 全長:62 (cm) 0.6t 2.2φ



COLANDER
パイプ柄 スクイ玉揚

0990 6500 - 特大	¥13,700
●28×25 (cm) 全長:62 (cm)	
0990 6501 - 大	¥11,900
●25×20 全長:58	
0990 6502 - 中	¥9,950
●22×19 全長:46.5	
0990 6503 - 小	¥8,750
●19×16 全長:38.5	
●0.6t 2.2φ	



COLANDER
スクイザル パイプ柄

0990 6324 - 24 cm	¥12,900
●25φ×H7 (cm)	
0990 6326 - 26	¥13,500
●27φ×H7.5	
0990 6228 - 28	¥14,000
●28.5φ×H8	
0990 6230 - 30	¥14,600
●30.5φ×H8.5	
0990 6233 - 33	¥15,700
●33.5φ×H9	
●handle:21 (cm) 0.6t 2.2φ	



COLANDER
ストレーナー/フック付

0990 6354 - 24 cm	¥13,000
●25φ×H7 (cm)	
0990 6356 - 26	¥13,700
●27φ×H7.5	
0990 6358 - 28	¥14,200
●28.5φ×H8	
0990 6360 - 30	¥14,800
●30.5φ×H8.5	
0990 6363 - 33	¥15,300
●33.5φ×H9	
●handle:22.5 (cm) 0.6t 2.2φ	



MIXING PADDLE
ミキシングパドル

0990 6000	¥15,000
●107 (cm)	
0990 6001	¥15,700
●122	



●特注で、ハンドル付きもできます。

COLANDER
パンチング給食用スクイ網

0990 6515 - 丸型	¥17,500
●24φ (cm)	
0990 6520 - すいのう型	¥22,900
●28×25	
●handle:101 (cm) 0.6t 3.0φ	



NOODLE STRAINER
尺長パンチングそば揚げ

0990 6510	¥11,000
●21φ (cm)	
●handle:50 (cm) 0.6t 3.0φ	



COLANDER
スクイザル

0990 6530 (柄長)	¥22,800
●30φ×H100 (cm)	
●handle:70 (cm) 0.5t 2.2φ	



●特注で、ハンドル付きもできます。

CLEANING COLANDER
ヘッドキャッチャー

0925 3291 - L	¥36,700
●24×18×H8.5 (cm) 全長:126 (cm)	
0925 3290 - S	¥32,800
●18.5×6.5×H10 全長:130	
●handle:120 (cm) 1.2t 3.0φ	



COLANDER/OBLONG
パンチ浅角バット

0990 3006	6枚取	¥14,800
●33.7×48.1×H5.2(cm)		
0990 3008	8	¥11,100
●29.4×40.9×H4.3		
0990 3010	10	¥9,400
●27×35.5×H4.2		
0990 3012	12	¥8,000
●26×32.5×H4.2		
0990 3015	15	¥6,950
●23.2×29.7×H4.2		
0990 3018	18	¥6,600
●20.6×26.7×H3.6		
0990 3021	21	¥5,500
●20×24.8×H3.4		
0990 3050	キャビネット判	¥4,000
●16.8×20.8×H3		
●0.6t 2.2φ		



FOOD STORAGE PAN PERFORATED
穴付角バット

0990 4986	6枚取	¥6,600
●33.8×48.2×H8(cm)		
0990 4988	8	¥5,100
●29.5×41×H6.7		
0990 4990	10	¥3,700
●27×35.5×H6.3		
0990 4992	12	¥3,400
●26×32.5×H5.3		



P.BASKET
パンチング具材網(ハンドル付)

0990 9250	¥35,700
●60×42×H4(cm) 1.0t 3.0φ5P	
(ハンドル除く)	



●OPTIONAL ハンドル付

MULTI PURPOSE BASKET
角ざる

0990 9100-L	¥44,700
●54×42.0×H18(cm)	
0990 9110-M	¥43,500
●49×38.5×H16	
●0.8t 6.0φ	



STACKING CONTAINER
スタッキングコンテナ

0990 9130	¥49,500
●53×30×H10(cm) 1.0t 10φ20P	
●受注生産	



STACKING CONTAINER
スタッキングコンテナ

0990 9120	¥51,500
●40×30×H9.5(cm) 0.8t 3φ5P	
●受注生産	



P.BASKET
パンチング 角ざる

0990 9200	¥34,500
●40.8×29.5×H10.5(cm)	
●10×10角穴 15P	

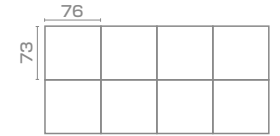
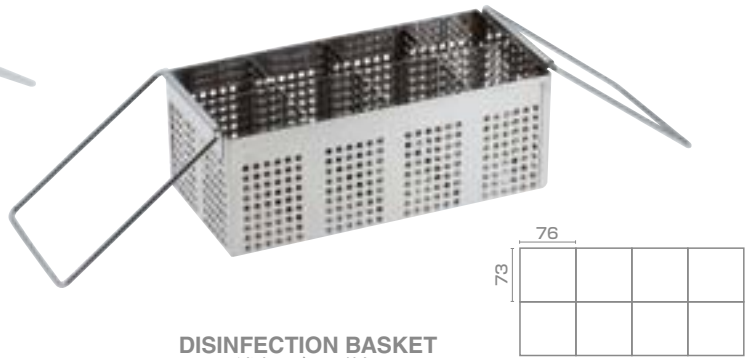

DISINFECTION BASKET
消毒かご/8ツ仕切

0950 0080 ¥39,600
●32×15.5×H12(cm)

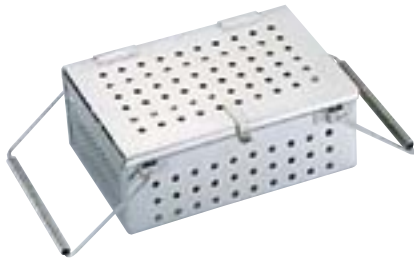

DISINFECTION BASKET for CUTLERY
スプーン消毒かご

0950 0010-L ¥10,600
●24×12×H8 (cm)
0950 0020-S ¥10,200
●18×12×H7
●0.6t 6.0φ



DISINFECTION BASKET for CHOPSTICKS
箸消毒かご

0950 0030-L ¥9,800
●26.0×10×H6.5(cm)
0950 0040-S ¥9,200
●20.5×9×H5.5
●0.6t 6.0φ



0950 0060



0950 0070

DISINFECTION BASKET
消毒かご

0950 0060 ¥32,600
●30×28.5×H9(cm) 0.7t 3.0φ
0950 0070 ¥30,000
●34×8×H8 0.7t 2.2φ
●特別注文品 SPECIAL ORDER



COLANDER
スプーンかご

0950 0050 ¥8,400
●20×8×H9(cm) 0.8t 2.2φ



●STACKABLE

SINK DUST BOX
三角コーナー

0950 0010 ¥7,250
●27×20.5×H10.5(cm) 0.5t 2.2φ

パンチング スペシャル メイド

BASKET / CONTAINER / DRAIN



CONTAINER
●62.5×43×H8 (cm)



BASKET
●46.5×34.5×H10 (cm)



CONTAINER
●59×43×H14.5 (cm)
●ハンドル含まず



BASKET
●42×36.3×H16.5 (cm)
●ハンドル含まず



CONTAINER
●53×30×H10 (cm)
●10φ



BASKET
●31×13×H15.5 (cm)
●ハンドル含まず



DRAIN
●28×18×H12.5 (内) (cm)



CONTAINER
●44×26×H13 (cm)
●5.0φ



DRAIN
●26.7×26.7×H18.5 (内) (cm)



BOIL BASKET
●27φ×H27 (cm)



STRAINER
●30×30 (cm)
●ハンドル長さ50 (cm)

TEMPURA RINGS (ST.ST)



TEMPURA RING-3
木柄 3連 天ぷらリング

0995 0060 ¥17,500
●9φ×27×H19.5(cm)



TEMPURA RING-3
共柄 3連 天ぷらリング

0995 0053 ¥19,800
●10φ×30×H20(cm)



TEMPURA RING-4
共柄 4連 天ぷらリング

0995 0054 ¥21,000
●9φ×36×H20.5(cm)



TEMPURA RING-5
共柄 5連 天ぷらリング

0995 0055 ¥25,600
●10φ×50×H20.5(cm)



TEMPURA RING-6
共柄 6連 天ぷらリング

0995 0056 ¥28,500
●9φ×54×H20(cm)



ハンドルの付け根にも裏側にも補強板付き。



TEMPURA RING-4
かき揚げリング S

0995 0030 ¥18,900
●11φ×H10(cm) 0.8t 5.0φ



手が熱くならない様にハンドルを伸ばしました。



TEMPURA RING-4
長柄木柄4連かき揚げリング

0995 0032 ¥23,500
●11φ×H15(cm)
handle:29(cm) 0.8t 5.0φ20P



TEMPURA RING-4
かき揚げリング M

0995 0031 ¥22,400
●11φ×H15(cm) 0.8t 5.0φ



TEMPURA RING-2
かき揚げリング M

0995 0021 ¥11,000
●12φ×H10(cm) 0.8t 5.0φ



TEMPURA RING-2
かき揚げリング S

0995 0020 ¥9,650
●8φ×H10(cm) 0.8t 5.0φ



TEMPURA RING-2
かき揚げリング(穴なし)

0995 0022 ¥7,600
●8.5φ×H8.5(cm) 0.8t



RING/TEMPURA
かき揚げリング

0995 0000 ¥3,700
●10φ×H10(cm) 0.8t 8.0φ
Handle:15(cm)

CONICAL STRAINERS (ST.ST)



CHINA CAP
スープこし (1mm穴)

0921 0150 - 15 cm	¥6,700
●15φ×31×H13 (cm)	
0921 0180 - 18	¥7,950
●18φ×36×H16	
0921 0210 - 21	¥9,900
●21φ×42×H18.5	
0921 0240 - 24	¥13,600
●24φ×50×H22	
0921 0270 - 27	¥21,700
●27φ×55×H25	
0921 0300 - 30	¥25,000
●30φ×61×H29	



CONICAL STRAINER
パンチングスープこし

0992 0518 - 18 cm	¥7,900
●18φ×H17 (cm)	
0992 0521 - 21	¥9,900
●21φ×H20.5	
0992 0524 - 24	¥10,700
●24φ×H23.5	
●0.5t 1.5φ	

CONICAL STRAINER
スープこし

0921 1120 - 12 cm	¥3,300
●12φ×H9 (cm)	
(板ハンドル)	
0921 1160 - 16	¥4,800
●16φ×H12.5	
0921 1180 - 18	¥5,300
●18φ×H14	
0921 1200 - 20	¥5,800
●20φ×H16.5	
0921 1220 - 22	¥6,500
●22φ×H17.5	
0921 1250 - 25	¥7,800
●25φ×H20	
(モナカハンドル)	



CHINOIS
シノア (25メッシュ)

0922 0210 - 21 cm	¥11,100
●21φ×42×H15.5 (cm)	
0922 0240 - 24	¥12,500
●24φ×47×H18	



CHINOIS
シノア / 板ハンドル

0922 0524 - 24 cm	¥7,900
●24φ×H18 (cm)	

PUNCHING STRAINER
パンチングストレーナー

0922 0115 - 15 cm	¥4,350
●16φ×H6.5 (cm)	
0922 0118 - 18	¥4,850
●20φ×H7	



MESH STRAINER
ラウンドメッシュストレーナー

0922 0405 - 5 cm	¥620
●5.0φ×16 (cm)	
0922 0407 - 7	¥750
●6.5φ×18	
0922 0408 - 8	¥980
●8.0φ×19	



OIL STRAINER

段付油こし 片手ハンドル(パンチ網仕様)

0992 0162	16-18 cm	¥5,950
替え網 S使用	21.5φ×H6(cm)	
0992 0202	20-22	¥7,350
替え網 M使用	25.5φ×H7.5	
0992 0242	24-26	¥8,400
替え網 L使用	29.5φ×H8	



OIL STRAINER

段付油こし 両手ハンドル(パンチ網仕様)

0992 0163	16-18 cm	¥5,300
替え網 S使用	21.5φ×H6(cm)	
0992 0203	20-22	¥6,600
替え網 M使用	25.5φ×H7.5	
0992 0243	24-26	¥7,600
替え網 L使用	29.5φ×H8	



OIL STRAINER

油こし 片手ハンドル(パンチ網仕様)

0992 1192	19 cm	¥5,100
替え網 S使用	20.0φ×H6(cm)	
0992 1212	21.5	¥5,300
替え網 S使用	23.0φ×H6	
0992 1232	23	¥6,350
替え網 M使用	24.5φ×H7	
0992 1262	26.5	¥7,150
替え網 L使用	27.5φ×H8	
0992 1302	30	¥7,800
替え網 L使用	30.5φ×H8	



OIL STRAINER

油こし 両手ハンドル(パンチ網仕様)

0992 1193	19 cm	¥4,550
替え網 S使用	20.0φ×H6(cm)	
0992 1213	21.5	¥5,100
替え網 S使用	23.0φ×H6	
0992 1233	23	¥5,700
替え網 M使用	24.5φ×H7	
0992 1263	26.5	¥6,550
替え網 L使用	27.5φ×H8	
0992 1303	30	¥7,300
替え網 L使用	30.5φ×H8	



OIL STRAINER/SPARE GAUZES

油こし用替えパンチ網

0992 0010	L	17.0φ (cm)	¥2,600
0992 0015	M	15.5φ	¥2,250
0992 0020	S	12.0φ	¥1,950

●1.1φ細目



段付油こし+KP組み合わせ



MIXING BOWLS (ST.ST)



ボール+ボールザル/浅型



MIXING BOWL/DEEP
深型ボール

0990 5015	15 cm	¥1,800
●16φ×H6.5(cm)		
0990 5018	18	¥2,000
●19.5φ×H7		
0990 5021	21	¥2,500
●22.5φ×H8.5		
0990 5024	24	¥2,900
●26φ×H9.5		
0990 5027	27	¥3,500
●29φ×H10		
0990 5030	30	¥3,950
●32φ×H11.5		

浅型パンチボールの受け皿として利用できます。



MIXING BOWL/SHALLOW
浅型ボール

0990 5515	15 cm	¥1,700
●16φ×H4.7(cm)		
0990 5518	18	¥1,950
●19.5φ×H5.5		
0990 5521	21	¥2,200
●22.5φ×H6.3		
0990 5524	24	¥2,600
●26φ×H6.7		
0990 5527	27	¥2,950
●29φ×H7.5		
0990 5530	30	¥3,500
●32φ×H8.3		

パンチング盆ザルボールの受け皿として利用できます。



BOWL
盆ザルボール(盆型ボール)

0990 5615	15 cm	¥1,500
●16φ×H3.4(cm)		
0990 5618	18	¥1,800
●19.5φ×H3.4		
0990 5621	21	¥1,900
●22.5φ×H3.4		
0990 5624	24	¥2,200
●26φ×H3.4		
0990 5627	27	¥2,500
●29φ×H3.4		
0990 5630	30	¥2,900
●32φ×H3.4		

パンチングそばザルの受け皿として利用できます。



COLANDER
穴付きボール

0990 5820	20 cm	¥1,400
●20φ×H7.0(cm) ●2.5φ		
0990 5822	22	¥1,600
●22φ×H7.5 ●2.5φ		
0990 5824	24	¥1,800
●24φ×H8.0 ●2.5φ		
0990 5826	26	¥2,100
●26φ×H9.0 ●2.5φ		
0990 5828	28	¥2,200
●28φ×H9.0 ●2.5φ		
0990 5830	30	¥2,450
●30φ×H10.0 ●2.5φ		
0990 5832	32	¥2,650
●32φ×H11.0 ●2.5φ		
0990 5834	34	¥3,000
●34φ×H11.5 ●2.5φ		
0990 5836	36	¥3,550
●36φ×H12.0 ●2.5φ		
0990 5838	38	¥3,700
●38φ×H13.0 ●2.5φ		
0990 5840	40	¥3,950
●40φ×H13.5 ●2.5φ		
0990 5850	50	¥8,100
●48φ×H16.0 ●2.5φ		
0990 5860	60	¥9,600
●58φ×H19.0 ●2.5φ		
0990 5870	70	¥11,900
●68φ×H21.0 ●5φ		
●ST.ST		



COLANDER/EU
パンチボール/ユーロスタイル

0990 5922	22 cm	¥3,400
●22φ×H9.4(cm)		
0990 5924	24	¥3,700
●24φ×H9.8		
0990 5926	26	¥4,000
●26φ×H10.7		
0990 5928	28	¥4,550
●28φ×H11.6		
0990 5930	30	¥5,100
●30φ×H12.5		
●18-8 ST.ST ●2φ4P		



COLANDER
パンチボール

0990 5964	24 cm	¥3,200
●24φ×H8(cm)		
0990 5966	26	¥3,500
●26φ×H8		
0990 5968	28	¥4,000
●28φ×H9		
0990 5970	30	¥4,400
●30φ×H9.9		
0990 5972	32	¥4,700
●32φ×H10.6		
●18-8 ST.ST ●2φ4P		



MIXING BOWL/SLANTED
ミキシングボール/スラント

0941 0216	16 cm	¥1,980
●16φ×H9.3(cm)		
0941 0218	18	¥2,300
●18φ×H10.3		
0941 0220	20	¥2,750
●20φ×H11.4		
0941 0222	22	¥3,100
●22φ×H12.5		
0941 0224	24	¥3,550
●24φ×H13.6		
0941 0226	26	¥4,100
●26φ×H14.6		



MIXING BOWL/DEEP
ミキシングボール/深型

0941 0120	20 cm	¥3,000
●20φ×H13(cm)		
●21-0 ST.ST		
※なくなり次第廃番です。		