



YUKIWA

HOTEL & RESTAURANT
2024

KITCHEN UTENSIL



UKパンチングシリーズ

ステンレス製パンチング板

金網製の煮籠のように針金が折損して、煮炊物の中に入り込む心配はありません。耐久力抜群にて、錆びに強く衛生的です。



パンチングシリーズのパンチ材は網に比べ、



パンチングシリーズは、丸穴7種類と角穴11種類の穴径の材質を使い、それぞれの用途に適した材料を選定して商品を開発しています。



1.1φ2P

【標準仕様穴径】1.1mm 2ピッチ
【材質】SUS-304
(18-8Stainless steel)
※板厚は0.5mmにのみ対応します。

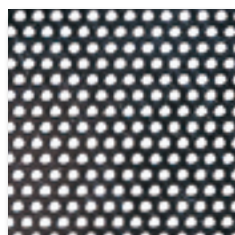

1.5φ3P

【標準仕様穴径】1.5mm 3ピッチ
【材質】SUS-304
(18-8Stainless steel)

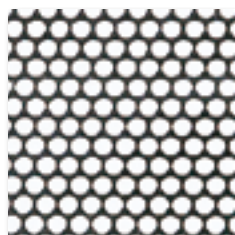

2.2φ4P

【標準仕様穴径】2.2mm 4ピッチ
【材質】SUS-304
(18-8Stainless steel)



3φ4P

【標準仕様穴径】3.0mm 4ピッチ
【材質】SUS-304
(18-8Stainless steel)

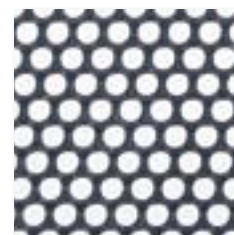

3φ5P

【標準仕様穴径】3.0mm 5ピッチ
【材質】SUS-304
(18-8Stainless steel)
※特注扱いです

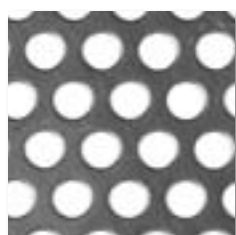

5φ8P

【標準仕様穴径】5.0mm 8ピッチ
【材質】SUS-304
(18-8Stainless steel)
※特注扱いです

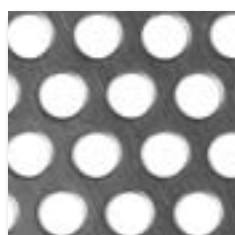

6φ9P

【標準仕様穴径】6.0mm 9ピッチ
【材質】SUS-304
(18-8Stainless steel)
※特注扱いです

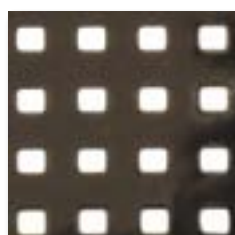

角穴 3×3mm

【標準仕様穴径】3.0×3.0mm
【材質】SUS-304
(18-8Stainless steel)

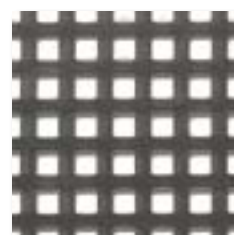

角穴 3.5×3.5mm

【標準仕様穴径】3.5×3.5mm
【材質】SUS-304
(18-8Stainless steel)

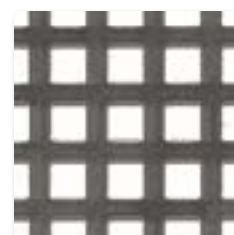

角穴 5×5mm

【標準仕様穴径】5.0×5.0mm
【材質】SUS-304
(18-8Stainless steel)

特注でさまざまなご要望にお応えいたします



■手差しハンドルもできます



■ハンドルも特注できます



■角穴タイプもできます



揚げザルに
限ります

■穴の大きさも
変えられます

揚げザルに
限ります



※製造上、目の形、大きさが異なる場合があります。
※表示以外の目の大きさについては、ご相談ください。

※特注で、目の大きさは変更できます。
※ピッチとは、穴の中心から穴の中心の距離です。



角穴 10×10mm

【標準仕様穴径】10.0×10.0mm
【材質】SUS-304
(18-8Stainless steel)



長角穴 3×30mm

【標準仕様穴径】3.0×30.0mm
【材質】SUS-304
(18-8Stainless steel)



長角穴 6×10mm

【標準仕様穴径】6.0×10.0mm
【材質】SUS-304
(18-8Stainless steel)

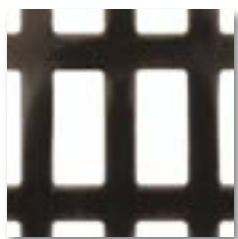

長角穴 6×15mm

【標準仕様穴径】6.0×15.0mm
【材質】SUS-304
(18-8Stainless steel)



長角穴 6×30mm

【標準仕様穴径】6.0×30.0mm
【材質】SUS-304
(18-8Stainless steel)



長角穴 4×35mm

【標準仕様穴径】4.0×35.0mm
【材質】SUS-304
(18-8Stainless steel)



角穴 20×20mm

【標準仕様穴径】20.0×20.0mm
【材質】SUS-304
(18-8Stainless steel)



長角穴 6×80mm

【標準仕様穴径】6.0×80.0mm
【材質】SUS-304
(18-8Stainless steel)

PUNCHING SERIES (ST.ST)



COLANDER/W/PROTECTION
揚げザル/横ビード補強入

0990 7400	42 cm	¥39,300	¥41,300
●42φ×H31 (cm)			
0990 7401	45	¥40,400	¥42,400
●45φ×H31			
0990 7402	48	¥41,600	¥43,700
●48φ×H31			
0990 7403	51	¥43,900 (5.0φ)	¥46,100 (2.2φ)
●0.7t (5.0φ)			



COLANDER/W/PROTECTION
揚げザル/縦ビード補強入

0990 7410	42 cm	¥39,300	¥41,300
●42φ×H31 (cm)			
0990 7411	45	¥40,400	¥42,400
●45φ×H31			
0990 7412	48	¥41,600	¥43,700
●48φ×H31			
0990 7413	51	¥43,900 (5.0φ)	¥46,100 (2.2φ)
●0.7t (5.0φ)			



COLANDER/W/PROTECTION
揚げザル/深型(補強付)

0990 7482	42 cm	¥40,400	¥42,400
●42φ×H31 (cm)			
0990 7485	45	¥41,600	¥43,700
●45φ×H31			
0990 7488	48	¥42,700	¥44,800
●48φ×H31			
0990 7491	51	¥45,000 (5.0φ)	¥47,300 (2.2φ)
●0.7t (5.0φ)			



COLANDER
揚げザル/深型

0990 7442	42 cm	¥37,000	¥38,100	¥39,200
●42φ×H31 (cm)				
0990 7445	45	¥38,100	¥39,200	¥40,400
●45φ×H31				
0990 7448	48	¥39,300	¥40,500	¥41,700
●48φ×H31				
0990 7451	51	¥42,700 (5.0φ)	¥44,000 (3.0φ)	¥45,300 (2.2φ)
●0.7t (5.0φ)				



COLANDER/W/PROTECTION
揚げザル/深型(補強付)

0990 7520	42 cm	¥43,400
●42φ×H31 (cm)		
0990 7521	45	¥44,500
●45φ×H31		
0990 7522	48	¥45,700
●48φ×H31		
0990 7523	51	¥48,000
●51φ×H31		
●0.7t 10φ 20P		



COLANDER
揚げザル/深型 バイブハンドル

0990 7540	42 cm	¥40,400	¥42,800
●42φ×H31 (cm)			
0990 7541	45	¥41,600	¥43,700
●45φ×H31			
0990 7542	48	¥42,700	¥44,800
●48φ×H31			
0990 7543	51	¥46,200 (5.0φ)	¥48,500 (2.2φ)
●0.7t (5.0φ)			



COLANDER
揚げザル/深型(手差しハンドル)

0990 7420	42 cm	¥46,200
●42φ×H31 (cm)		
0990 7421	45	¥47,400
●45φ×H31		
0990 7422	48	¥49,700
●48φ×H31		
0990 7423	51	¥52,000
●51φ×H31		
●0.7t 3.5×3.5角穴		





COLANDER
揚げザル/平底

0990 7245	45 cm	¥34,700	¥35,700	¥36,800
●45φ×H17.5(cm)				
0990 7248	48	¥35,900	¥37,000	¥38,100
●48φ×H18				
0990 7251	51	¥38,300	¥39,400	¥40,600
●51φ×H19.5				
0990 7255	55	¥46,300	¥47,700	¥49,100
●55φ×H20				
0990 7260	60	¥52,000	¥53,600	¥55,200
●60φ×H22				
0990 7265	65	¥57,900 (5.0φ)	¥59,600 (3.0φ)	¥61,400 (2.2φ)
●65φ×H23 ●0.7t (2.2φ) *特注サイズもできます				



COLANDER/W/PROTECTION
揚げザル/平底(補強付)

0990 7275	45 cm	¥35,900	¥37,000	¥38,000
●45φ×H17.5(cm)				
0990 7278	48	¥37,000	¥38,100	¥39,200
●48φ×H18				
0990 7281	51	¥40,500	¥41,700	¥43,000
●51φ×H19.5				
0990 7285	55	¥48,600	¥50,000	¥51,500
●55φ×H20				
0990 7290	60	¥53,200	¥55,000	¥56,700
●60φ×H22				
0990 7295	65	¥59,000 (5.0φ)	¥60,800 (3.0φ)	¥62,600 (2.2φ)
●65φ×H23 ●0.7t (2.2φ) *特注サイズもできます				



COLANDER
揚げザル/平底 パイプハンドル

0990 7370	45 cm	¥34,700
●45φ×H17.5(cm)		
0990 7371	48	¥38,100
●48φ×H18		
0990 7372	51	¥39,300
●51φ×H19.5		
0990 7373	55	¥47,400
●55φ×H20		
0990 7374	60	¥53,100
●60φ×H22		
0990 7375	65	¥59,000
●65φ×H23 ●0.7t 10φ 15P *特注サイズもできます		



COLANDER
揚げザル/平底

0990 7320	45 cm	¥42,700
●45φ×H17.5(cm)		
0990 7321	48	¥43,900
●48φ×H18		
0990 7322	51	¥48,500
●51φ×H19.5		
0990 7323	55	¥54,300
●55φ×H20		
0990 7324	60	¥60,000
●60φ×H22		
0990 7325	65	¥65,800
●65φ×H23 ●0.7t 3.5×3.5角穴 *特注サイズもできます		



*特注で固定式
ハンドルもできます。

COLANDER
揚げザル/底バンチング

0990 7340	45 cm	¥37,600
●45φ×H17.5(cm)		
0990 7341	48	¥38,700
●48φ×H18		
0990 7342	51	¥41,000
●51φ×H19.5		
0990 7343	55	¥48,500
●55φ×H20		
0990 7344	60	¥53,100
●60φ×H22		
0990 7345	65	¥58,900
●65φ×H23 ●0.7t 2.2φ *特注品 ●SPECIAL ORDER		



SPINNER
遠心脱水ざる(ハンドル付)

0990 7590 ¥89,500
●外46φ×内45φ×H31(cm)
※特注品
●SPECIAL ORDER



SPINNER
遠心脱水ざる(ハンドルなし)/角淵

0990 7580 ¥83,000
●外50φ×内45φ×H27(cm)
※特注品
●SPECIAL ORDER



SPINNER
遠心脱水ざる(ハンドルなし)/R淵

0990 7581 ¥83,000
●外50φ×内45φ×H27(cm)
※特注品
●SPECIAL ORDER

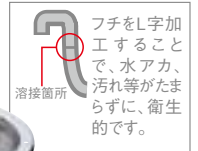
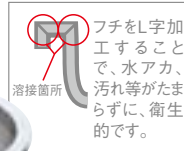

COLANDER/W/PROTECTION
揚げザル/深・深型(補強付)

0990 7531 45 cm ¥64,800
●45φ×H50(cm)
0990 7532 48 ¥67,500
●48φ×H50
0990 7533 51 ¥72,400
●51φ×H50
●0.8t 3.0φ 5P



COLANDER/SQUARE
揚げザル/角型

0990 7210 33 cm ¥32,500
●33×33×H14(cm)
0990 7211 37 ¥41,800
●37.5×37.5×H16.5
0990 7212 43 ¥49,700
●43×43×H18.7
●0.7t 2.2φ



DOLLY
ドローリー

0990 9900 -650 ¥77,300
0990 9902 -510 ¥71,000
0990 9904 -400 ¥68,000
●18-8 キャスター使用
●揚げザル/深型は別売です。

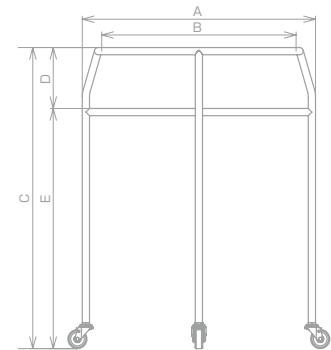

	A 外径(mm)	B 上枠内径(mm)	C 全高(mm)	D 中受深さ(mm)	E 中受高さ(mm)
0990 9900	750	650	810	140	670
0990 9902	610	510	810	140	670
0990 9904	500	400	810	140	670

●キャスター SUS304
●50φ×4/自在 ストッパー付×2 ストッパー無×2



COLANDER
水切りザル

0990 4818	18 cm	¥6,250
●19.5φ×H7.5(cm)	●0.23(kg)	
0990 4821	21	¥6,850
●22.5φ×H8.5	●0.30	
0990 4824	24	¥7,750
●25.5φ×H9.5	●0.38	
0990 4827	27	¥9,950
●28.5φ×H11	●0.48	
0990 4830	30	¥11,500
●32.0φ×H12.5	●0.56	
●0.6t 2.2φ		



COLOR PLATE
コランダ-用 カラープレート

0990 4000	ピンク	¥1,480
0990 4001	ブルー	¥1,480
0990 4002	イエロー	¥1,480
0990 4003	グリーン	¥1,480
●12×1.5(cm)		



COLANDER
浅型ザル

●OPTIONAL ハンドル付

0990 7033	33 cm	¥15,700
●35.5φ×H14(cm)	●0.78(kg)	
0990 7035	35	¥17,500
●37.5φ×H15.5	●0.86	
0990 7037	37.5	¥20,500
●40.0φ×H16	●0.95	
0990 7040	40	¥23,500
●42.5φ×H17	●1.16	
0990 7043	43	¥25,500
●45.5φ×H17.5	●1.32	
0990 7046	46	¥29,000
●48.5φ×H19.5	●1.47	
0990 7050	50	¥33,500
●52.5φ×H21	●1.70	
0990 7055	55	¥42,900
●57.5φ×H21	●2.05	
0990 7060	60	¥46,500
●62.5φ×H22	●2.65	
0990 7065	65	¥50,800
●67.5φ×H22	●2.92	
●0.7t 2.2φ		



●OPTIONAL パイプハンドル

COLANDER
浅型ザル/手付(可動式)

0990 7010	40 cm	¥28,500
●42.5φ×H17(cm)	●1.46(kg)	
0990 7013	43	¥30,500
●45.5φ×H17.5	●1.58	
0990 7016	46	¥33,500
●48.5φ×H19.5	●1.75	
0990 7020	50	¥38,500
●52.5φ×H21	●1.97	
0990 7025	55	¥47,500
●57.5φ×H21	●2.39	
●0.7t 2.2φ		



●OPTIONAL ハンドル付

COLANDER
深型ザル

0990 7127	27.5 cm	¥16,500
●30.0φ×H16.5(cm)	●容量:3升 ●0.69(kg)	
0990 7130	30	¥18,700
●32.5φ×H18	●容量:4 ●0.82	
0990 7133	33	¥20,500
●35.5φ×H20	●容量:5 ●1.05	
0990 7135	35	¥25,600
●37.5φ×H21.5	●容量:8 ●1.17	
0990 7137	37.5	¥29,800
●40.0φ×H23	●容量:10 ●1.29	
●0.7t 2.2φ		



COLANDER
米揚げザル

0990 7227	27.5 cm	¥18,600
●30.0φ×H16.5(cm)	●容量:3升 ●0.65(kg)	
0990 7230	30	¥19,800
●32.5φ×H18	●容量:4 ●0.80	
0990 7233	33	¥21,000
●35.5φ×H20	●容量:5 ●0.96	
0990 7235	35	¥29,000
●37.5φ×H21.5	●容量:8 ●1.07	
0990 7237	37.5	¥31,500
●40.0φ×H23	●容量:10 ●1.23	
●0.7t 1.5φ		



PUNCHING SERIES (st.st)



COLANDER
手付浅型ザル

0990 6933	33 cm ●35.5 φ×H12.7 (cm)	¥23,000
0990 6935	35 ●37.5 φ×H14	¥24,000
0990 6937	37.5 ●40.0 φ×H14.6	¥25,300
0990 6940	40 ●42.5 φ×H15.8	¥27,600
0990 6943	43 ●45.5 φ×H16.2	¥31,000
0990 6946	46 ●48.5 φ×H17.2	¥32,200
0990 6950	50 ●52.5 φ×H19.4	¥37,000
0990 6955	55 ●57.5 φ×H19.8	¥45,000
0990 6960	60 ●62.5 φ×H20.3	¥49,500
0990 6965	65 ●67.0 φ×H20.5 ●0.8t 脇3φ穴 底4φ穴	¥53,000



●OPTIONAL ハンドル付

COLANDER
巾広浅型ザル

0990 7073	33 cm ●35.5 φ×H14 (cm)	¥16,100
0990 7075	35 ●37.5 φ×H15.5	¥19,600
0990 7077	37.5 ●40.0 φ×H16 ●0.7t 2.2φ	¥23,000
0990 7080	40 ●42.5 φ×H17	¥25,300
0990 7083	43 ●45.5 φ×H17.5	¥27,600
0990 7086	46 ●48.5 φ×H19.5	¥31,000
0990 7090	50 ●52.5 φ×H21	¥35,700
0990 7095	55 ●57.5 φ×H21	¥44,900
0990 7100	60 ●62.5 φ×H22	¥47,100
0990 7105	65 ●67.5 φ×H22 ●0.8t 2.2φ	¥51,700



(0.5t 1.5φ)

COLANDER
揚げザル

0990 6124	24 cm ●26 φ×H7 (cm)	¥5,800
0990 6126	26 ●28 φ×H7.5	¥6,550
0990 6128	28 ●30 φ×H8	¥7,250
0990 6130	30 ●32 φ×H8.5	¥7,800
0990 6133	33 ●35 φ×H9 ●0.5t 1.5φ	¥9,500



(0.5t 1.5φ)

COLANDER
ためザル

0990 6024	24 cm ●26 φ×H1.7 (cm)	¥5,400
0990 6026	26 ●28 φ×H1.9	¥6,000
0990 6028	28 ●30 φ×H2	¥6,600
0990 6030	30 ●32 φ×H2.2	¥7,580
0990 6033	33 ●35 φ×H2.4 ●0.5t 1.5φ	¥9,150



(0.8t 2.2φ)

0990 6143	43 ●43 φ×H14.5	¥19,800
0990 6146	46 ●46 φ×H14.5	¥27,200
0990 6150	50 ●50 φ×H14.5 ●0.8t 2.2φ	¥33,500



(0.8t 2.2φ)

0990 6043	43 ●46 φ×H5.5	¥17,900
0990 6046	46 ●49 φ×H5.5	¥19,000
0990 6050	50 ●53 φ×H5.5 ●0.8t 2.2φ	¥22,500





COLANDER/W/HANDLES

手付パンチボール(手付ボールザル/深型)

0990 4115	15 cm	¥4,550
●16φ×H6.5(cm)		
0990 4118	18	¥5,000
●20φ×H7		
0990 4121	21	¥6,000
●23φ×H8.5		
0990 4124	24	¥7,850
●26φ×H9.5		
0990 4127	27	¥10,000
●29φ×H10		
0990 4130	30	¥12,500
●32φ×H11.5		
●0.6t 1.2φ		
●サイズはハンドルを含んでおりません。		



COLANDER/ROUND/DEEP

深型パンチボール(ボールザル/深型)

0990 4015	15 cm	¥2,880
●16φ×H6.5(cm)		
0990 4018	18	¥3,550
●20φ×H7		
0990 4021	21	¥4,450
●23φ×H8.5		
0990 4024	24	¥5,770
●26φ×H9.5		
0990 4027	27	¥8,200
●29φ×H10		
0990 4030	30	¥9,980
●32φ×H11.5		
●0.6t 1.2φ		



COLANDER/ROUND/SHALLOW

浅型パンチボール(ボールザル/浅型)

0990 4515	15 cm	¥2,550
●16φ×H4.7(cm)		
0990 4518	18	¥2,980
●20φ×H5.5		
0990 4521	21	¥3,860
●23φ×H6.3		
0990 4524	24	¥5,050
●26φ×H6.7		
0990 4527	27	¥7,200
●29φ×H7.5		
0990 4530	30	¥9,000
●32φ×H8.3		
●0.6t 1.2φ		



COLANDER/ROUND

パンチング盆ザルボール(盆ザル)

0990 4615	15 cm	¥2,270
●16φ×H3.4(cm)		
0990 4618	18	¥2,770
●20φ×H3.4		
0990 4621	21	¥3,400
●23φ×H3.4		
0990 4624	24	¥4,400
●26φ×H3.4		
0990 4627	27	¥6,400
●29φ×H3.4		
0990 4630	30	¥7,850
●32φ×H3.4		
●0.5t 1.5φ		



COLANDER/ROUND

パンチングそばザル(浅型盆ザル)

0990 4715	15 cm	¥2,000
●16φ×H1.8(cm)		
0990 4718	18	¥2,550
●20φ×H1.8		
0990 4721	21	¥3,100
●23φ×H1.8		
0990 4724	24	¥3,950
●26φ×H1.8		
0990 4727	27	¥5,780
●29φ×H1.8		
0990 4730	30	¥6,950
●32φ×H1.8		
●0.5t 1.5φ		

HACCP対応食品衛生 対象商品



HACCPとは

HACCP(ハサップ)は、米国航空宇宙局(NASA)が宇宙食の製造にあたって食品の安全性を確実に保証できる衛生管理手法として開発した方法です。食品の安全性を確保する上で最も効果的な手法であるとして、世界的にも高く評価され、すでに多くの国で導入されています。



COLANDER
HACCP 水切りボール

電解
仕上

0990 5118	18 cm	¥5,750
●20φ×H7(cm)		
0990 5121	21	¥6,450
●23φ×H8		
0990 5124	24	¥7,750
●26.5φ×H9		
0990 5127	27	¥9,850
●29.5φ×H10		
0990 5130	30	¥11,500
●33φ×H11		
●0.6t 2.2φ		



COLANDER
HACCP 浅型ザル

0990 6980	33 cm	¥16,000
●35.5φ×H12(cm)		
0990 6982	35	¥18,100
●37.5φ×H13.5		
0990 6984	37.5	¥20,400
●40.0φ×H14		
●0.7t 2.2φ		
0990 6986	40	¥23,800
●42.5φ×H15		
0990 6988	43	¥26,300
●45.5φ×H15.5		
0990 6990	46	¥29,500
●48.5φ×H17.5		
0990 6992	50	¥34,000
●52.5φ×H19		
0990 6994	55	¥43,300
●57.5φ×H19		
0990 6996	60	¥46,400
●62.5φ×H20		
0990 6998	65	¥51,000
●67.5φ×H20		
●0.8t 2.2φ		



COLANDER/ROUND/DEEP

HACCP 深型パンチボール(ボールザル/深型)		
0990 4050	15 cm	¥3,200
●16φ×H6.5(cm)		
0990 4052	18	¥3,760
●20φ×H7		
0990 4054	21	¥4,800
●23φ×H8.5		
0990 4056	24	¥6,030
●26φ×H9.5		
0990 4058	27	¥8,400
●29φ×H10		
0990 4060	30	¥10,600
●32φ×H11.5		
●0.6t 1.2φ		



COLANDER/ROUND/SHALLOW

HACCP 浅型パンチボール(ボールザル/浅型)		
0990 4550	15 cm	¥2,840
●16φ×H4.7(cm)		
0990 4552	18	¥3,300
●20φ×H5.5		
0990 4554	21	¥4,300
●23φ×H6.3		
0990 4556	24	¥5,460
●26φ×H6.7		
0990 4558	27	¥7,560
●29φ×H7.5		
0990 4560	30	¥9,350
●32φ×H8.3		
●0.6t 1.2φ		



COLANDER/ROUND

HACCP パンチング盆ザルボール(盆ザル)		
0990 4650	15 cm	¥2,470
●16φ×H3.4(cm)		
0990 4652	18	¥2,990
●20φ×H3.4		
0990 4654	21	¥3,660
●23φ×H3.4		
0990 4656	24	¥4,640
●26φ×H3.4		
0990 4658	27	¥6,490
●29φ×H3.4		
0990 4660	30	¥7,880
●32φ×H3.4		
●0.5t 1.5φ		



COLANDER/ROUND

HACCP パンチングそばザル(浅型盆ザル)		
0990 4750	15 cm	¥2,270
●16φ×H1.8(cm)		
0990 4752	18	¥2,780
●20φ×H1.8		
0990 4754	21	¥3,300
●23φ×H1.8		
0990 4756	24	¥4,220
●26φ×H1.8		
0990 4758	27	¥5,920
●29φ×H1.8		
0990 4760	30	¥7,160
●32φ×H1.8		
●0.5t 1.5φ		



COLANDER
HACCP 深型ザル

0990 7150	27.5 cm	¥17,000
●30.0φ×H14.8(cm) ●容量:3升		
0990 7152	30	¥18,100
●32.5φ×H16.3 ●容量:4		
0990 7154	33	¥20,400
●35.5φ×H18 ●容量:5		
0990 7156	35	¥26,000
●37.5φ×H19.5 ●容量:8		
0990 7158	37.5	¥29,400
●40.0φ×H21 ●容量:10		
●0.8t 2.2φ		



COLANDER for STOCK POT

スープ取りザル

0926 3036	36 cm	¥49,800
●35φ×H35 (cm)		
0926 3039	39	¥53,100
●38φ×H38		
0926 3042	42	¥63,500
●41φ×H41		
0926 3045	45	¥70,900
●44φ×H44		
0926 3048	48	¥80,900
●47φ×H47		
●0.7t 2.2φ		

*48cmは受注生産です。
*特注サイズも出来ます。



COLANDER for STOCK POT

半丸スープ取りザル

0926 3136	36 cm	¥34,700
●35φ×18×H30 (cm)		
0926 3139	39	¥37,000
●38φ×20×H33		
0926 3142	42	¥41,700
●41φ×21×H36		
0926 3145	45	¥48,600
●44φ×23×H39		
0926 3148	48	¥49,800
●47φ×25×H42		
●0.7t 2.2φ		

*48cmは受注生産です。
*特注サイズも出来ます。



COLANDER

蒸しザル(手付)

0990 7350	50 cm	¥57,500
●50φ×H10 (cm)		
0990 7360	60	¥68,200
●60φ×H10		
●0.7t 2.2φ		

*特注サイズも出来ます。



COLANDER

蒸しザル(手付)

0990 7365		¥114,000
●74φ×64φ×H18 (cm)		
●0.8t 6φ15P		



COLANDER

丸スープ取りザル

0926 3000		¥33,800
●20φ×H29.5 (cm)		
●0.6t 1.5φ		

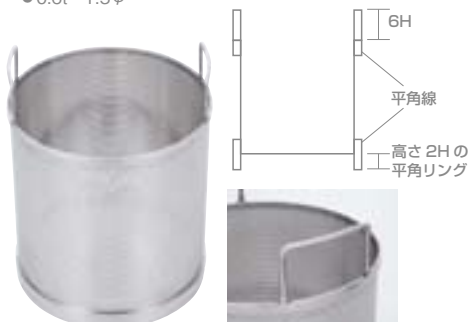

SPAGHETTI BASKET

スパゲッティカゴ

0925 3075		¥38,500
●27.5φ×H29 (cm)		
●0.5t 1.5φ3P		





ROUND FRYER/W/HANDLS
丸フライヤー/ハンドル付

0925 3710 —26 cm	¥10,300
●26φ (cm)	
0925 3720 —28	¥11,000
●28φ	
0925 3730 —30	¥11,700
●30φ	
0925 3740 —33	¥12,700
●33φ	
●0.6t 1.5φ	



ROUND FRYER/W/HANDLS
丸フライヤー/かす揚げ(ハンドル付)

0925 3810 —26 cm	¥9,150
●26φ (cm)	
0925 3820 —28	¥9,500
●28φ	
0925 3830 —30	¥10,200
●30φ	
●0.6t 3.0φ	



丸キッチンポットと組合せて
使用出来ます。



丸キッチンポットと組合せて
使用出来ます。



BOIL-BASKET/Double Handles
ボイルバスケット/両手ハンドル

0925 3122 21cm	¥14,200
●21φ×H18 (cm)	
0925 3125 24	¥16,400
●24φ×H21	
●0.5t 1.5φ	
*特注サイズも出来ます。	



BOIL-BASKET/Singl Handle
ボイルバスケット/片手ハンドル

0925 3115 15 cm	¥9,900
●15φ×H11 (cm)	
0925 3118 18	¥11,000
●18φ×H13	
0925 3121 21	¥14,000
●21φ×H15	
0925 3124 24	¥14,600
●24φ×H16	
●0.5t 1.5φ	
*特注サイズも出来ます。	



BOIL-BASKET
スパゲッティストレーナー

0925 3180	¥16,800
●25φ×H12 (cm)	
handle:25 (cm) 0.6t 1.5φ	



COLANDER for STOCK BASKET
スープ取りカゴ

0926 3090 36 cm	¥82,500
●36φ×H36 (cm)	
0926 3091 57	¥149,000
●57φ×H27	
●0.7t 2.2φ	
*特注品(小豆・大豆煮豆カゴ)	
●SPECIAL ORDER	



COLANDER for STOCK BASKET
スープ取りカゴ

0926 3095 50cm	¥153,000
●50φ×H33.5 (cm)	
*特注品	
●SPECIAL ORDER	





FRYER
ポテトフライヤー

0925 3205-S ¥15,200
●28.5×12.5×H11 (cm) 0.7t 2.2φ
*特注サイズも出来ます。



FRYER
ポテトフライヤー

0925 3200-L ¥16,500
●28.5×17.5×H11 (cm) 0.7t 2.2φ
*特注サイズも出来ます。



BOIL-BASKET
パンチング フライドポテトバスケット

0925 3220 ¥15,500
●21×15×H15 (cm) 0.7t 5.0φ



FRYER
フライヤー

0925 3215 ¥21,000
●34×12.3×H12 (cm)
handle:30 (cm) 1.0t 6.0φ



BOIL-BASKET
パンチング スパゲッティバスケット

0925 3210 ¥20,700
●29×10×H15 (cm) 0.6t 1.5φ



BOIL-BASKET
冷凍麺てぼ

0925 3400-共柄 ¥11,600
0925 3410-パイプ柄 ¥13,700
●16×4.5×H14 (cm)
handle:17 (cm) 0.6t 2.2φ



BOIL-BASKET
パンチング フランクフルトバスケット

0925 3230 ¥13,600
●17φ×H17 (cm) 0.6t 5.0φ



STRAINER
こしてぼ

0925 3080 ¥8,500
●17φ×H11.5 (cm)
handle:24.5 (cm) 0.5t 1.1φ



木柄



共柄



パイプ柄



シリコン柄

NOODLE STRAINER
深型底平煮ざるうどんてぼ

0925 3000-(木柄) ¥8,750
0925 3001-(共柄) ¥8,300
0925 3002-(パイプ柄) ¥11,200
NEW 0925 3003-(シリコン柄) ¥10,600
●13φ×H20 (cm)
handle:18.5 (cm) 0.5t 2.2φ



STRAINER
こしてぼ/みそこし

0925 3310 ¥3,980
●12.5φ×H11.2×30 (全高) (cm)
●2.2φ



STRAINER
みそこし

0925 3320 ¥1,950
●10φ×H6.5×23 (全高) (cm)
●1.8φ



COLOR HANDLE STRAINER

カラーハンドル付てぼ



RED



BLUE



YELLOW



GREEN



COLOR HANDLE STRAINER
カラーハンドル付てぼ

L	●14φ×H18(cm)	¥6,000
S	●14φ×H13	¥5,600

●シリコンハンドル ●各色共通価格

SIZE	商品コード			
	レッド	ブルー	イエロー	グリーン
L	0925 3151	0925 3152	0925 3153	0925 3154
S	0925 3141	0925 3142	0925 3143	0925 3144

NOODLE STRAINER
てぼ/シリコンハンドル

0925 3150-L	¥5,800
●14φ×H18(cm)	
0925 3140-S	¥5,500
●14φ×H13	



木柄

NOODLE STRAINER
丸底うどんてぼ/木柄

0925 3040-L	¥8,700
●13.5φ×H17.5(cm)	
0925 3050-S	¥8,250
●12.5φ×H16.5	
●handle:18.5(cm) 0.5t 2.2φ	



共柄

NOODLE STRAINER
丸底うどんてぼ/共柄

0925 3041-L	¥8,200
●13.5φ×H17.5(cm)	
0925 3051-S	¥8,000
●12.5φ×H16.5	
●handle:18.5(cm) 0.5t 2.2φ	



パイプ柄

NOODLE STRAINER
丸底うどんてぼ/パイプ柄

0925 3042-L	¥10,300
●13.5φ×H17.5(cm)	
0925 3052-S	¥9,850
●12.5φ×H16.5	
●handle:18.5(cm) 0.5t 2.2φ	



シリコンハンドル

NEW NOODLE STRAINER
丸底うどんてぼ/シリコンハンドル

0925 3043-L	¥9,800
●13.5φ×H17.5(cm)	
0925 3053-S	¥9,400
●12.5φ×H16.5	
●handle:18.5(cm) 0.5t 2.2φ	



木柄

NOODLE STRAINER
底平煮ざる/一体成形/木柄

0925 3451-L	¥6,200
●17φ×H15.5(cm)	
0925 3461-M	¥5,800
●16.2φ×H14.5	
0925 3471-S	¥5,400
●15.2φ×H13.5	
●handle:18.5 0.5t 2.5φ6P	



共柄

NOODLE STRAINER
底平煮ざる/一体成形/共柄

0925 3452-L	¥5,600
●17φ×H15.5(cm)	
0925 3462-M	¥5,200
●16.2φ×H14.5	
0925 3472-S	¥4,800
●15.2φ×H13.5	
●handle:18.5 0.5t 2.5φ6P	



パイプ柄

NOODLE STRAINER
底平煮ざる/一体成形/パイプ柄

0925 3453-L	¥7,900
●17φ×H15.5(cm)	
0925 3463-M	¥7,600
●16.2φ×H14.5	
0925 3473-S	¥7,200
●15.2φ×H13.5	
●handle:18.5 0.5t 2.5φ6P	



シリコンハンドル

NOODLE STRAINER
底平煮ざる/一体成形/シリコンハンドル

0925 3450-L	¥6,400
●17φ×H15.5(cm)	
0925 3460-M	¥6,100
●16.2φ×H14.5	
0925 3470-S	¥5,800
●15.2φ×H13.5	
●handle:18.5 0.5t 2.5φ6P	

KITCHEN
UTENSIL



SPAGHETTI STRAINER
スパゲッティてぼ/M

0925 3065—(木柄) ¥9,900
0925 3067—(パイプ柄) ¥11,600
●13.5φ×H18(cm)
handle:18.5(cm) 0.5t 1.5φ

SPAGHETTI STRAINER
スパゲッティてぼ/L

0925 3060—(木柄) ¥10,900
0925 3062—(パイプ柄) ¥12,400
●15.5φ×H22(cm)
handle:18.5(cm) 0.5t 1.5φ

SPAGHETTI STRAINER
スパゲッティてぼ/深型

0925 3070—(木柄) ¥10,900
0925 3072—(パイプ柄) ¥12,400
●11.5φ×H30(cm)
handle:18.5(cm) 0.5t 1.5φ

NEW SPAGHETTI STRAINER
スパゲッティてぼ/シリコンハンドル

0925 3068—M ¥11,000
●13.5φ×H18(cm)
0925 3063—L ¥11,800
●15.5φ×H22
0925 3073—深型 ¥11,800
●11.5φ×H30
●handle:18.5 0.5t 1.5φ



木柄

NOODLE STRAINER
平底うどん揚げ/木柄

0925 3195 ¥12,200
●18.7φ×H17(cm)
handle:18.5(cm) 0.5t 3.0φ



共柄

NOODLE STRAINER
平底うどん揚げ/共柄

0925 3196 ¥11,800
●18.7φ×H17(cm)
handle:18.5(cm) 0.5t 3.0φ



パイプ柄

NOODLE STRAINER
平底うどん揚げ/パイプ柄

0925 3197 ¥13,300
●18.7φ×H17(cm)
handle:18.5(cm) 0.5t 3.0φ



シリコンハンドル

NEW NOODLE STRAINER
平底うどん揚げ/シリコンハンドル

0925 3198 ¥12,600
●18.7φ×H17(cm)
handle:18.5(cm) 0.5t 3.0φ



木柄

NOODLE STRAINER
底平煮ざる/木柄

0925 3010—L ¥9,100
●16.5φ×H16(cm)
0925 3020—M ¥8,800
●15φ×H15
0925 3030—S ¥8,000
●13.5φ×H14
●handle:18.5 0.5t 2.2φ



共柄

NOODLE STRAINER
底平煮ざる/共柄

0925 3011—L ¥8,600
●16.5φ×H16(cm)
0925 3021—M ¥7,900
●15φ×H15
0925 3031—S ¥7,650
●13.5φ×H14
●handle:18.5 0.5t 2.2φ



パイプ柄

NOODLE STRAINER
底平煮ざる/パイプ柄

0925 3012—L ¥11,000
●16.5φ×H16(cm)
0925 3022—M ¥10,000
●15φ×H15
0925 3032—S ¥9,500
●13.5φ×H14
●handle:18.5 0.5t 2.2φ



シリコンハンドル

NEW NOODLE STRAINER
底平煮ざる/シリコンハンドル

0925 3013—L ¥10,500
●16.5φ×H16(cm)
0925 3023—M ¥9,500
●15φ×H15
0925 3033—S ¥9,000
●13.5φ×H14
●handle:18.5 0.5t 2.2φ



NOODLE STRAINER
角てぼ/縦型/木柄

0925 3100-L ¥10,800
●18×11.5×H14 (cm)
0925 3105-S ¥9,100
●18×11.5×H8.5
handle:18.5 (cm) 0.7t 2.2φ



NOODLE STRAINER
角てぼ/縦型/パイプ柄

0925 3102-L ¥11,800
●18×11.5×H14 (cm)
0925 3107-S ¥11,300
●18×11.5×H8.5
handle:18.5 (cm) 0.7t 2.2φ



NEW **NOODLE STRAINER**
角てぼ/縦型/シリコンハンドル

0925 3103-L ¥11,200
●18×11.5×H14 (cm)
0925 3108-S ¥10,700
●18×11.5×H8.5
handle:18.5 (cm) 0.7t 2.2φ



NOODLE STRAINER
角てぼ/横型/パイプ柄

0925 3092-L ¥11,800
●18×11.5×H14 (cm)
0925 3097-S ¥11,300
●18×11.5×H8.5
handle:18.5 (cm) 0.7t 2.2φ



NOODLE STRAINER
角てぼ/横型/木柄

0925 3090-L ¥11,200
●18×11.5×H14 (cm)
0925 3095-S ¥9,200
●18×11.5×H8.5
handle:18.5 (cm) 0.7t 2.2φ



NEW **NOODLE STRAINER**
角てぼ/横型/シリコンハンドル

0925 3093-L ¥10,600
●18×11.5×H14 (cm)
0925 3098-S ¥8,700
●18×11.5×H8.5
handle:18.5 (cm) 0.7t 2.2φ



NOODLE STRAINER
角型うどん揚げ/木柄

0925 3190 ¥14,500
●17.5×15.2×H13 (cm)
handle:18.5 (cm) 0.6t 2.2φ



NOODLE STRAINER
角型うどん揚げ/共柄

0925 3191 ¥14,200
●17.5×15.2×H13 (cm)
handle:18.5 (cm) 0.6t 2.2φ



NOODLE STRAINER
角型うどん揚げ/パイプ柄

0925 3192 ¥15,400
●17.5×15.2×H13 (cm)
handle:18.5 (cm) 0.6t 2.2φ



NEW **NOODLE STRAINER**
角型うどん揚げ/シリコンハンドル

0925 3193 ¥14,600
●17.5×15.2×H13 (cm)
handle:18.5 (cm) 0.6t 2.2φ



NOODLE STRAINER
そば揚げ/縦型

0990 6550	18 cm	¥8,400
●18φ (cm)		
0990 6551	21	¥8,860
●21φ		
0990 6552	24	¥10,200
●24φ		
●handle:36(cm) 0.6t 3.0φ		



NOODLE STRAINER
そば揚げ/横型

0990 6560	18 cm	¥8,450
●18φ (cm)		
0990 6561	21	¥8,900
●21φ		
0990 6562	24	¥10,200
●24φ		
●handle:27(cm) 0.6t 3.0φ		



NEW **NOODLE STRAINER**
そば揚げ/横型/シリコンハンドル

0990 6565	18 cm	¥8,200
●18φ (cm)		
0990 6566	21	¥8,650
●21φ		
0990 6567	24	¥9,950
●24φ		
●handle:27(cm) 0.6t 3.0φ		



SKIMMER
丸かす揚げ/板ハンドル

0925 3611	23 cm	¥5,670
●23φ (cm)		
全長:67.5(cm) handle:47.5(cm)		
0925 3621	20	¥5,050
●20φ		
全長:59 handle:40		
0925 3631	17	¥4,430
●17φ		
全長:47 handle:31		
●0.7t 2.2φ		
●ツバ付できます。		



SKIMMER
丸かす揚げ/パイプハンドル

0925 3610	23 cm	¥7,480
●23φ (cm)		
全長:67.5(cm) handle:47.5(cm)		
0925 3620	20	¥6,590
●20φ		
全長:59 handle:40		
0925 3630	17	¥5,560
●17φ		
全長:47 handle:31		
●0.7t 2.2φ		



OIL STRAINER
背油こし(丸かす揚げ)

0990 6581	20 cm	¥6,700
●20φ 全長:41(cm)		
0990 6580	23	¥7,550
●23φ 全長:43.5		
●0.7t 2.2φ		



SKIMMER
角かす揚げ/パイプハンドル

0925 3510-L		¥7,600
●18×22.5(cm) 全長:70(cm)		
0925 3520-M		¥6,400
●14×19 全長:57.5		
●0.7t 2.2φ		



SKIMMER
角かす揚げ/板ハンドル

0925 3511-L		¥5,850
●18×22.5(cm) 全長:70(cm)		
0925 3521-M		¥4,950
●14×19 全長:57.5		
●0.7t 2.2φ		
0925 3531-S		¥4,300
●10×14 全長:43.5		
●0.6t 2.2φ		
●ツバ付できます。		



SQ SKIMMER
スクエア スキンマー

0925 3590		¥5,400
●15×15(cm) 全長:45(cm)		
●0.6t 2.2φ		

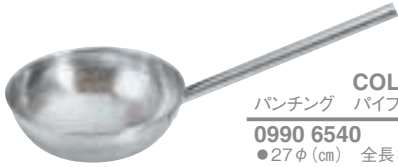

COLANDER
パンチング バイブ柄 丸型 スクイ玉揚
0990 6540 ￥14,700
●27φ (cm) 全長:62 (cm) 0.6t 2.2φ



COLANDER
バイブ柄 スクイ玉揚
0990 6500 - 特大 ￥13,700
●28×25 (cm) 全長:62 (cm)
0990 6501 - 大 ￥12,800
●25×20 全長:58
0990 6502 - 中 ￥9,950
●22×19 全長:46.5
0990 6503 - 小 ￥9,200
●19×16 全長:38.5
●0.6t 2.2φ



●特注で、ハンドル付きも
できます。

COLANDER
パンチング給食用スクイ網
0990 6515 - 丸型 ￥17,500
●24φ (cm)
0990 6520 - すいのう型 ￥22,900
●28×25
●handle:101 (cm) 0.6t 3.0φ



COLANDER
スクイザル バイブ柄
0990 6324 - 24 cm ￥13,500
●25φ×H7 (cm)
0990 6326 - 26 ￥13,500
●27φ×H7.5
0990 6228 - 28 ￥14,700
●28.5φ×H8
0990 6230 - 30 ￥15,000
●30.5φ×H8.5
0990 6233 - 33 ￥15,700
●33.5φ×H9
●handle:21 (cm) 0.6t 2.2φ



NOODLE STRAINER
尺長パンチングそば揚げ
0990 6510 ￥11,600
●21φ (cm)
●handle:50 (cm) 0.6t 3.0φ



COLANDER
ストレーナー/フック付
0990 6354 - 24 cm ￥13,000
●25φ×H7 (cm)
0990 6356 - 26 ￥13,700
●27φ×H7.5
0990 6358 - 28 ￥14,200
●28.5φ×H8
0990 6360 - 30 ￥14,800
●30.5φ×H8.5
0990 6363 - 33 ￥15,300
●33.5φ×H9
●handle:22.5 (cm) 0.6t 2.2φ



COLANDER
スクイザル
0990 6530 (柄長) ￥23,900
●30φ×H100 (cm)
●handle:70 (cm) 0.6t 2.2φ



OIL STRAINER
角型油かす揚げ
0925 3550 ￥17,500
●23×20×全長54 (cm)



OIL STRAINER
角型油かす揚げ
0925 3560 ￥18,900
●23×23×全長30 (cm)
●0.5t 1.1φ2P



SKIMMER
角かす揚げ/ツバ付
特注品



COLANDER/OBLONG
パンチ浅角バット

0990 3006	6枚取	¥15,200
●33.7×48.1×H5.2(cm)		
0990 3008	8	¥11,500
●29.4×40.9×H4.3		
0990 3010	10	¥9,700
●27×35.5×H4.2		
0990 3012	12	¥8,100
●26×32.5×H4.2		
0990 3015	15	¥7,100
●23.2×29.7×H4.2		
0990 3018	18	¥6,950
●20.6×26.7×H3.6		
0990 3021	21	¥5,750
●20×24.8×H3.4		
0990 3050	キャビネット判	¥4,000
●16.8×20.8×H3		
●0.6t 2.2φ		



FOOD STORAGE PAN PERFORATED
穴付角バット

0990 4986	6枚取	¥5,950
●33.8×48.2×H8(cm)		
0990 4988	8	¥4,600
●29.5×41×H6.7		
0990 4990	10	¥3,300
●27×35.5×H6.3		
0990 4992	12	¥3,100
●26×32.5×H5.3		



●OPTIONAL ハンドル付

MULTI PURPOSE BASKET
角ざる

0990 9100-L	¥44,700
●54×42.0×H18(cm)	
0990 9110-M	¥43,500
●49×38.5×H16	
●0.8t 6.0φ	



P.BASKET
パンチング具材網(ハンドル付)

0990 9250	¥35,700
●60×42×H4(cm) 1.0t 3.0φ5P	
(ハンドル除く)	



STACKING CONTAINER
スタッキングコンテナ

0990 9130	¥49,500
●53×30×H10(cm) 1.0t 10φ20P	
●受注生産	



STACKING CONTAINER
スタッキングコンテナ

0990 9120	¥51,500
●40×30×H9.5(cm) 0.8t 3φ5P	
●受注生産	



P.BASKET
パンチング 角ざる

0990 9200	¥34,500
●40.8×29.5×H10.5(cm)	
●10×10角穴 15P	

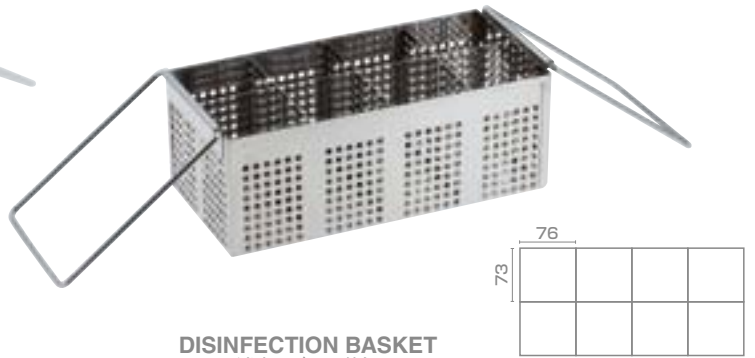

DISINFECTION BASKET
消毒かご/8ツ仕切

0950 0080 ¥39,600
●32×15.5×H12(cm)

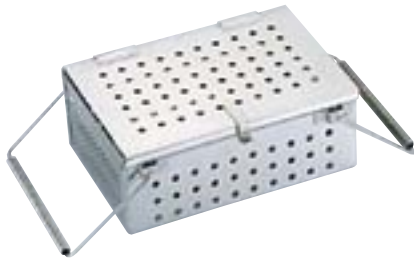

DISINFECTION BASKET for CUTLERY
スプーン消毒かご

0950 0010-L ¥11,500
●24×12×H8 (cm)
0950 0020-S ¥11,000
●18×12×H7
●0.6t 6.0φ



DISINFECTION BASKET for CHOPSTICKS
箸消毒かご

0950 0030-L ¥10,800
●26.0×10×H6.5(cm)
0950 0040-S ¥10,100
●20.5×9×H5.5
●0.6t 6.0φ



COLANDER
スプーンかご

0950 0050 ¥8,400
●20×8×H9(cm) 0.8t 2.2φ



0950 0060



0950 0070

DISINFECTION BASKET
消毒かご

0950 0060 ¥32,600
●30×28.5×H9(cm) 0.7t 3.0φ
0950 0070 ¥21,000
●34×8×H8 0.7t 2.2φ
●特別注文品 SPECIAL ORDER



●STACKABLE

SINK DUST BOX
三角コーナー

0995 0010 ¥7,500
●27×20.5×H10.5(cm) 0.5t 2.2φ



MIXING PADDLE
ミキシングパドル

0990 6000 ¥15,500
●107 (cm)
0990 6001 ¥16,100
●122

パンチング スペシャル メイド

BASKET / CONTAINER / DRAIN



CONTAINER
●62.5×43×H8 (cm)



BASKET
●46.5×34.5×H10 (cm)



CONTAINER
●59×43×H14.5 (cm)
●ハンドル含まず



BASKET
●42×36.3×H16.5 (cm)
●ハンドル含まず



CONTAINER
●53×30×H10 (cm)
●10φ



BASKET
●31×13×H15.5 (cm)
●ハンドル含まず



DRAIN
●28×18×H12.5 (内) (cm)



CONTAINER
●44×26×H13 (cm)
●5.0φ



DRAIN
●26.7×26.7×H18.5 (内) (cm)



BOIL BASKET
●27φ×H27 (cm)



STRAINER
●30×30 (cm)
●ハンドル長さ50 (cm)

TEMPURA RINGS (ST.ST)



TEMPURA RING-3
木柄 3連 天ぷらリング

0995 0060 ¥17,500
●9φ×27×H19.5(cm)



TEMPURA RING-3
共柄 3連 天ぷらリング

0995 0053 ¥19,800
●10φ×30×H20(cm)



TEMPURA RING-4
共柄 4連 天ぷらリング

0995 0054 ¥21,000
●9φ×36×H20.5(cm)



TEMPURA RING-5
共柄 5連 天ぷらリング

0995 0055 ¥25,600
●10φ×50×H20.5(cm)



TEMPURA RING-6
共柄 6連 天ぷらリング

0995 0056 ¥28,500
●9φ×54×H20(cm)



ハンドルの付け根にも裏側にも補強板付き。



TEMPURA RING-4
かき揚げリング S

0995 0030 ¥19,400
●11φ×H10(cm) 0.8t 5.0φ



手が熱くならない様にハンドルを伸ばしました。



TEMPURA RING-4
長柄木柄4連かき揚げリング

0995 0032 ¥23,500
●11φ×H15(cm)
handle:29(cm) 0.8t 5.0φ20P



TEMPURA RING-4
かき揚げリング M

0995 0031 ¥22,400
●11φ×H15(cm) 0.8t 5.0φ



TEMPURA RING-2
かき揚げリング M

0995 0021 ¥11,600
●12φ×H10(cm) 0.8t 5.0φ



TEMPURA RING-2
かき揚げリング S

0995 0020 ¥10,100
●8φ×H10(cm) 0.8t 5.0φ



TEMPURA RING-2
かき揚げリング(穴なし)

0995 0022 ¥8,000
●8.5φ×H8.5(cm) 0.8t



RING/TEMPURA
かき揚げリング

0995 0000 ¥3,900
●10φ×H10(cm) 0.8t 8.0φ
Handle:15(cm)

CONICAL STRAINERS (ST.ST)



CHINA CAP
スープこし (1mm穴)

0921 0150 - 15 cm	¥7,350
●15φ×31×H13 (cm)	
0921 0180 - 18	¥8,500
●18φ×36×H16	
0921 0210 - 21	¥11,000
●21φ×42×H18.5	
0921 0240 - 24	¥14,500
●24φ×50×H22	
0921 0270 - 27	¥22,700
●27φ×55×H25	
0921 0300 - 30	¥25,500
●30φ×61×H29	



CONICAL STRAINER
パンチングスープこし

0992 0518 - 18 cm	¥8,400
●18φ×H17 (cm)	
0992 0521 - 21	¥10,600
●21φ×H20.5	
0992 0524 - 24	¥11,400
●24φ×H23.5	
●0.5t 1.5φ	

CONICAL STRAINER
スープこし

0921 1120 - 12 cm	¥3,150
●12φ×H9 (cm) (板ハンドル)	
0921 1160 - 16	¥4,550
●16φ×H12.5	
0921 1180 - 18	¥5,000
●18φ×H14	
0921 1200 - 20	¥5,500
●20φ×H16.5	
0921 1220 - 22	¥6,150
●22φ×H17.5	
0921 1250 - 25	¥7,400
●25φ×H20 (モナカハンドル)	



CHINOIS
シノア (25メッシュ)

0922 0210 - 21 cm	¥11,700
●21φ×42×H15.5 (cm)	
0922 0240 - 24	¥13,000
●24φ×47×H18	



CHINOIS
シノア / 板ハンドル

0922 0524 - 24 cm	¥7,800
●24φ×H18 (cm)	

PUNCHING STRAINER
パンチングストレーナー

0922 0115 - 15 cm	¥4,900
●16φ×H6.5 (cm)	
0922 0118 - 18	¥5,300
●20φ×H7	



MESH STRAINER
ラウンドメッシュストレーナー

0922 0405 - 5 cm	¥590
●5.0φ×16 (cm)	
0922 0407 - 7	¥710
●6.5φ×18	
0922 0408 - 8	¥930
●8.0φ×19	



OIL STRAINER

段付油こし 片手ハンドル(パンチ網仕様)

0992 0162	16-18 cm	¥6,150
替え網 S使用	21.5φ×H6(cm)	
0992 0202	20-22	¥7,600
替え網 M使用	25.5φ×H7.5	
0992 0242	24-26	¥8,650
替え網 L使用	29.5φ×H8	



OIL STRAINER

段付油こし 両手ハンドル(パンチ網仕様)

0992 0163	16-18 cm	¥5,560
替え網 S使用	21.5φ×H6(cm)	
0992 0203	20-22	¥6,930
替え網 M使用	25.5φ×H7.5	
0992 0243	24-26	¥7,980
替え網 L使用	29.5φ×H8	



OIL STRAINER

油こし 片手ハンドル(パンチ網仕様)

0992 1192	19 cm	¥5,250
替え網 S使用	20.0φ×H6(cm)	
0992 1212	21.5	¥5,450
替え網 S使用	23.0φ×H6	
0992 1232	23	¥6,550
替え網 M使用	24.5φ×H7	
0992 1262	26.5	¥7,360
替え網 L使用	27.5φ×H8	
0992 1302	30	¥8,000
替え網 L使用	30.5φ×H8	



OIL STRAINER

油こし 両手ハンドル(パンチ網仕様)

0992 1193	19 cm	¥4,780
替え網 S使用	20.0φ×H6(cm)	
0992 1213	21.5	¥5,360
替え網 S使用	23.0φ×H6	
0992 1233	23	¥5,990
替え網 M使用	24.5φ×H7	
0992 1263	26.5	¥6,880
替え網 L使用	27.5φ×H8	
0992 1303	30	¥7,670
替え網 L使用	30.5φ×H8	



OIL STRAINER/SPARE GAUZES

油こし用替えパンチ網

0992 0010	L	17.0φ (cm)	¥2,680
0992 0015	M	15.5φ	¥2,350
0992 0020	S	12.0φ	¥2,070

●1.1φ細目



段付油こし+KP組み合わせ





COLANDER
穴付きボール

0990 5820 -20 cm	¥1,400
●20φ×H7.0 (cm) ●2.5φ	
0990 5822 -22	¥1,600
●22φ×H7.5 ●2.5φ	
0990 5824 -24	¥1,800
●24φ×H8.0 ●2.5φ	
0990 5826 -26	¥2,100
●26φ×H9.0 ●2.5φ	
0990 5828 -28	¥2,200
●28φ×H9.0 ●2.5φ	
0990 5830 -30	¥2,450
●30φ×H10.0 ●2.5φ	
0990 5832 -32	¥2,650
●32φ×H11.0 ●2.5φ	
0990 5834 -34	¥3,000
●34φ×H11.5 ●2.5φ	
0990 5836 -36	¥3,550
●36φ×H12.0 ●2.5φ	
0990 5838 -38	¥3,700
●38φ×H13.0 ●2.5φ	
0990 5840 -40	¥3,950
●40φ×H13.5 ●2.5φ	
0990 5850 -50	¥8,100
●48φ×H16.0 ●5φ	
0990 5860 -60	¥9,600
●58φ×H19.0 ●2.5φ	
0990 5870 -70	¥11,900
●68φ×H21.0 ●5φ	
●ST.ST	



COLANDER/EU
パンチボール/ユーロスタイル

0990 5922 -22 cm	¥3,400
●22φ×H9.4 (cm)	
0990 5924 -24	¥3,700
●24φ×H9.8	
0990 5926 -26	¥4,000
●26φ×H10.7	
0990 5928 -28	¥4,550
●28φ×H11.6	
0990 5930 -30	¥5,100
●30φ×H12.5	
NEW 0990 5932 -32	¥5,700
●32φ×H13	
●18-8 ST.ST ●2φ4P	



COLANDER
パンチボール

0990 5964 -24 cm	¥3,100
●24φ×H8 (cm)	
0990 5966 -26	¥3,400
●26φ×H8	
0990 5968 -28	¥3,900
●28φ×H9	
0990 5970 -30	¥4,300
●30φ×H9.9	
0990 5972 -32	¥4,600
●32φ×H10.6	
●18-8 ST.ST ●2φ4P	



NEW **COLANDER**
穴付ボール/手付

0990 5753 -23 cm	¥2,900
●23φ×H8 (cm)	
0990 5755 -25	¥3,300
●25φ×H8.7	
0990 5757 -27	¥3,700
●27φ×H9.2	
0990 5759 -29	¥4,100
●29φ×H10.2	
0990 5761 -31	¥4,500
●31φ×H10.6	
●18-8 ST.ST ●2.2φ4P	



NEW **COLANDER**
ミキシングボール/手付

0990 5783 -23 cm	¥2,400
●23φ×H8 (cm)	
0990 5785 -25	¥2,600
●25φ×H8.7	
0990 5787 -27	¥2,900
●27φ×H9.2	
0990 5789 -29	¥3,100
●29φ×H10.2	
0990 5791 -31	¥3,600
●31φ×H10.6	
●18-8 ST.ST	



ボール+ボールザル/浅型



MIXING BOWL/DEEP
深型ボール

0990 5015	15 cm	¥1,900
● 16φ × H6.5 (cm)		
0990 5018	18	¥2,100
● 19.5φ × H7		
0990 5021	21	¥2,500
● 22.5φ × H8.5		
0990 5024	24	¥2,900
● 26φ × H9.5		
0990 5027	27	¥3,500
● 29φ × H10		
0990 5030	30	¥3,950
● 32φ × H11.5		

浅型パンチボールの受け皿として利用できます。



MIXING BOWL/SHALLOW
浅型ボール

0990 5515	15 cm	¥1,800
● 16φ × H4.7 (cm)		
0990 5518	18	¥2,000
● 19.5φ × H5.5		
0990 5521	21	¥2,200
● 22.5φ × H6.3		
0990 5524	24	¥2,600
● 26φ × H6.7		
0990 5527	27	¥3,000
● 29φ × H7.5		
0990 5530	30	¥3,500
● 32φ × H8.3		

パンチング盆ザルボールの受け皿として利用できます。



BOWL
盆ザルボール(盆型ボール)

0990 5615	15 cm	¥1,600
● 16φ × H3.4 (cm)		
0990 5618	18	¥1,800
● 19.5φ × H3.4		
0990 5621	21	¥1,900
● 22.5φ × H3.4		
0990 5624	24	¥2,300
● 26φ × H3.4		
0990 5627	27	¥2,500
● 29φ × H3.4		
0990 5630	30	¥2,900
● 32φ × H3.4		

パンチングそばザルの受け皿として利用できます。



MIXING BOWL/DEEP
ミキシングボール/深型

0941 0120-20	cm	¥2,900
● 20φ × H13 (cm)		
● 21-0 ST.ST		

※なくなり次第廃番です。



MIXING BOWL/SLANTED
ミキシングボール/スラント

0941 0216	16 cm	¥1,900
● 16φ × H9.3 (cm)		
0941 0218	18	¥2,200
● 18φ × H10.3		
0941 0220	20	¥2,700
● 20φ × H11.4		
0941 0222	22	¥2,900
● 22φ × H12.5		
0941 0224	24	¥3,400
● 24φ × H13.6		
0941 0226	26	¥3,900
● 26φ × H14.6		





FOOD CONTAINER
食缶

0994 0206 - 6ℓ	¥43,600
● 23.5φ × H24 (cm)	
● 約3.0 (kg)	
0994 0210 - 10	¥54,000
● 29φ × H28	
● 約4.7	
0994 0214 - 14	¥60,500
● 32φ × H31	
● 約5.4	

保温性能

	2時間後	6時間後
6 ℓ	95℃ → 82℃以上	95℃ → 62℃以上
10 ℓ	95℃ → 82℃以上	95℃ → 63℃以上
14 ℓ	95℃ → 85℃以上	95℃ → 70℃以上



FOOD CONTAINER

パッキン・フック付ストックポット/角深型

0903 0100 - 10.5 cm	¥7,800
● 10.5×10.5×H10.5 (cm)	● 約1.1 (ℓ)
0903 0120 - 12	¥8,700
● 12×12×H12	● 約1.6
0903 0130 - 13.5	¥9,900
● 13.5×13.5×H13.5	● 約2.3
0903 0150 - 15	¥13,000
● 15×15×H15	● 約3.1
0903 0160 - 16.5	¥13,700
● 16.5×16.5×H16.5	● 約4.2
0903 0180 - 18	¥15,500
● 18×18×H18	● 約5.3
0903 0190 - 19.5 (手付)	¥19,000
● 19.5×19.5×H19.5	● 約7.0
0903 0210 - 21 (手付)	¥21,500
● 21×21×H21	● 約8.6
0903 0240 - 24 (手付)	¥30,500
● 24×24×H24	● 約12.6
0903 0270 - 27 (手付)	¥39,400
● 27×27×H27	● 約18
0903 0300 - 30 (手付)	¥46,500
● 30×30×H30	● 約25
0903 0330 - 33 (手付)	¥67,700
● 33×33×H33	● 約35
0903 0360 - 36 (手付)	¥81,000
● 36×36×H36	● 約46



FOOD STORAGE PAN/DEEP/OBLONG
フードコンテナ

0990 1380 7号	¥8,300
● 23×33×H8.5 (cm)	
0990 1381 8	¥9,400
● 24.3×35×H8.7	
0990 1382 9	¥9,900
● 26×36.5×H9	
0990 1383 10	¥12,400
● 28.3×40.5×H9.3	



FOOD CONTAINER

パッキン・フック付ストックポット

0903 0340 - 34 cm (手付)	¥48,900
● (内寸) 34×24×H21 (cm)	● 約17 (ℓ)

HACCP



SQ-DEEP KITCHEN POT
角・深型キッチンポット

0902 0080- 8 cm ● 8 × 8 × H8 (cm) ● 約0.46(ℓ)	¥3,100
0902 0090- 9 ● 9 × 9 × H9 ● 約0.7	¥3,300
0902 0100-10.5 ● 10.5 × 10.5 × H10.5 ● 約1.1	¥4,150
0902 0120-12 ● 12 × 12 × H12 ● 約1.6	¥4,750
0902 0130-13.5 ● 13.5 × 13.5 × H13.5 ● 約2.3	¥5,400
0902 0150-15 ● 15 × 15 × H15 ● 約3.1	¥6,300
0902 0160-16.5 ● 16.5 × 16.5 × H16.5 ● 約4.2	¥7,200
0902 0180-18 ● 18 × 18 × H18 ● 約5.3	¥8,150
0902 0190-19.5 (手付) ● 19.5 × 19.5 × H19.5 ● 約7.0	¥10,500
0902 0210-21 (手付) ● 21 × 21 × H21 ● 約8.6	¥12,700
0902 0220-22.5 (手付) ● 22.5 × 22.5 × H22.5 ● 約10.8	¥15,500
0902 0240-24 (手付) ● 24 × 24 × H24 ● 約12.6	¥17,600
0902 0250-25.5 (手付) ● 25.5 × 25.5 × H25.5 ● 約15.7	¥19,800
0902 0270-27 (手付) ● 27 × 27 × H27 ● 約18	¥22,700
0902 0280-28.5 (手付) ● 28.5 × 28.5 × H28.5 ● 約22	¥25,400
0902 0300-30 (手付) ● 30 × 30 × H30 ● 約25	¥28,300
0902 0330-33 (手付) ● 33 × 33 × H33 ● 約35	¥45,900
0902 0360-36 (手付) ● 36 × 36 × H36 ● 約46	¥58,900
0902 0390-39 (手付) ● 39 × 39 × H39 ● 約59	¥69,800

※8cm・9cmの蓋には引掛けは付いていません。



SQ-DEEP KITCHEN POT **抗菌**
角・深型キッチンポット

0972 0210- 21 (手付)	¥12,000
0972 0240- 24 (手付)	¥16,000



SQ-DEEP KITCHEN POT
HACCP 角・深型キッチンポット

0902 2080- 8 cm ● 8 × 8 × H8 (cm) ● 約0.46(ℓ)	¥3,800
0902 2090- 9 ● 9 × 9 × H9 ● 約0.7	¥4,050
0902 2100-10.5 ● 10.5 × 10.5 × H10.5 ● 約1.1	¥5,100
0902 2120-12 ● 12 × 12 × H12 ● 約1.6	¥5,700
0902 2130-13.5 ● 13.5 × 13.5 × H13.5 ● 約2.3	¥6,700
0902 2150-15 ● 15 × 15 × H15 ● 約3.1	¥7,800
0902 2160-16.5 ● 16.5 × 16.5 × H16.5 ● 約4.2	¥8,900
0902 2180-18 ● 18 × 18 × H18 ● 約5.3	¥10,100
0902 2190-19.5 (手付) ● 19.5 × 19.5 × H19.5 ● 約7.0	¥12,500
0902 2210-21 (手付) ● 21 × 21 × H21 ● 約8.6	¥14,800

※10.5~21cmまでは便利な目盛付です。



浅型

深浅型

深型



SQ-KITCHEN POT/M-DEEP
角・深浅型キッチンポット

0904 1080- 8 cm ● 8 × 8 × H6 (cm) ● 約0.35(ℓ)	¥2,800
0904 1090- 9 ● 9 × 9 × H7 ● 約0.5	¥3,000
0904 1100-10.5 ● 10.5 × 10.5 × H8.5 ● 約0.85	¥3,700
0904 1120-12 ● 12 × 12 × H10 ● 約1.3	¥4,400
0904 1130-13.5 ● 13.5 × 13.5 × H11 ● 約1.85	¥4,750
0904 1150-15 ● 15 × 15 × H12 ● 約2.45	¥5,750
0904 1160-16.5 ● 16.5 × 16.5 × H13 ● 約3.3	¥6,650
0904 1180-18 ● 18 × 18 × H15 ● 約4.5	¥7,700



SQ-KITCHEN POT/SHALLOW
角・浅型キッチンポット

0905 0080- 8 cm ● 8 × 8 × H4.5 (cm) ● 約0.25(ℓ)	¥2,050
0905 0090- 9 ● 9 × 9 × H5 ● 約0.35	¥2,430
0905 0100-10.5 ● 10.5 × 10.5 × H5.5 ● 約0.5	¥2,720
0905 0120-12 ● 12 × 12 × H6.5 ● 約0.85	¥3,450
0905 0130-13.5 ● 13.5 × 13.5 × H7 ● 約1.2	¥3,780
0905 0150-15 ● 15 × 15 × H8 ● 約1.7	¥4,610
0905 0160-16.5 ● 16.5 × 16.5 × H8.5 ● 約2.2	¥5,000
0905 0180-18 ● 18 × 18 × H9.5 ● 約2.9	¥6,100
0905 0190-19.5 ● 19.5 × 19.5 × H10 ● 約3.7	¥6,900

SQ-STOCK POTS (ST.ST)



0903 0530

SQ-DEEP KITCHEN POT/D-WALLED
角・深型キッチンポット/ダブルウォール

- 0903 0530**—13.5 cm ¥8,400
●(外寸)13.5×13.5×H13.5(cm)
●(内寸)12×12×H12(cm) ●約1.6(ℓ)
- 0903 0550**—15 ¥9,500
●(外寸)15×15×H15
●(内寸)13.5×13.5×H13.5 ●約2.3
●STACKING



SAUCE POT
角タレいれ

- 0901 1090** ¥3,000
●9.7×9.7×H9.3(cm) ●0.5(ℓ)
●材質:モリブデン SUS316



SAUCE POT
角タレいれ/蓋付(丁番)

- 0901 1099** ¥5,400
●9.7×9.7×H9.3(cm) ●0.5(ℓ)
●材質:モリブデン SUS316



SQ-DEEP KITCHEN POT
角・深型キッチンポット/蓋付(丁番)

- 0902 0099**— 9 cm ¥4,400
●9×9×H9(cm)
- 0902 0109**—10.5 ¥5,300
●10.5×10.5×H10.5
- 0902 0129**—12 ¥5,700
●12×12×H12



SQ-DEEP KITCHEN POT/WITH COLOR PLATE
角・深型キッチンポット STプレート付

*各サイズは240ページの角・深型キッチンポットを参考にしてください。
*STプレートは4色(ピンク・ブルー・イエロー・グリーン)ございます。

SIZE	商品コード				価格
	ピンク	ブルー	イエロー	グリーン	
10.5cm	0902 1100	0902 1103	0902 1106	0902 1109	¥5,300
12	0902 1120	0902 1123	0902 1126	0902 1129	¥6,100
15	0902 1150	0902 1153	0902 1156	0902 1159	¥8,000
18	0902 1180	0902 1183	0902 1186	0902 1189	¥10,500
24	0902 1240	0902 1243	0902 1246	0902 1249	¥21,500



SQ-DEEP KITCHEN POT/WITH CARD HOLDER
名札付角・深型キッチンポット

- 0904 0130**—13.5 cm ¥6,700
●13.5×13.5×H13.5(cm) ●約2.3(ℓ)
- 0904 0150**—15 ¥7,700
●15×15×H15 ●約3.1
- 0904 0160**—16.5 ¥8,800
●16.5×16.5×H16.5 ●約4.2
- 0904 0180**—18 ¥9,800
●18×18×H18 ●約5.3
- 0904 0190**—19.5(手付) ¥12,600
●19.5×19.5×H19.5 ●約7.0
- 0904 0210**—21 (手付) ¥14,500
●21×21×H21 ●約8.6
- 0904 0240**—24 (手付) ¥20,000
●24×24×H24 ●約12.6
- 0904 0270**—27 (手付) ¥27,000
●27×27×H27 ●約18
- 0904 0300**—30 (手付) ¥32,000
●30×30×H30 ●約25



LID FOR SQ-DEEP KITCHEN POT
角キッチンポット用割蓋

- 0903 2080**— 8cm ¥1,700
●8×8(cm)
- 0903 2090**— 9 ¥1,800
●9×9
- 0903 2100**—10.5 ¥1,900
●10.5×10.5
- 0903 2120**—12 ¥2,000
●12×12
- 0903 2130**—13.5 ¥2,350
●13.5×13.5
- 0903 2150**—15 ¥2,600
●15×15
- 0903 2160**—16.5 ¥3,250
●16.5×16.5
- 0903 2180**—18 ¥3,800
●18×18
- 0903 2210**—21 ¥4,180
●21×21



DEEP KITCHEN POT
深型キッチンポット(PC)

0901 0080 -8 cm ●8×8×H8 (cm)	●約0.4 (ℓ)	¥1,900
0901 0090 -9 ●9×9×H9	●約0.5	¥2,100
0901 0100 -10.5 ●10.5×10.5×H10.5	●約0.9	¥3,000
0901 0120 -12 ●12×12×H12	●約1.5	¥3,900
0901 0130 -13.5 ●13.5×13.5×H13.5	●約2.2	¥4,600
0901 0150 -15 ●15×15×H15	●約2.8	¥5,000
0901 0160 -16.5 ●16.5×16.5×H16.5	●約3.7	¥5,800
0901 0180 -18 ●18×18×H18	●約4.9	¥6,300
0901 0210 -21 ●21×21×H21	●約7.9	¥9,150
0901 0215 -21 手付 ●21×21×H21 (ハンドル含まない)	●約7.9	¥12,400

●耐熱温度:120℃ ●材質:POLYCARBONATE
※8cm・9cmの蓋には引掛けは付いていません。
※10.5~21cmまでは便利な目盛付です。



CONDIMENT POT
薬味入/角KPフタ付

0901 0830 -7 cm ●7×7×H7 (cm)	¥1,890
0901 0800 -8 ●8×8×H8	¥2,100
0901 0810 -9 ●9×9×H9	¥2,300

●材質:POLYCARBONATE



CONDIMENT POT
薬味入/フック付フタ

0901 0880 -7 cm ●7×7×H7 (cm)	¥1,790
0901 0850 -8 ●8×8×H8	¥1,980
0901 0860 -9 ●9×9×H9	¥2,150

●材質:POLYCARBONATE



LID FOR DEEP KITCHEN POT
深型キッチンポット用割蓋/ポリカーボネイト用

0903 2010 -10.5 cm ●10.5×10.5 (cm)	¥2,400
0903 2012 -12 ●12×12	¥2,450
0903 2013 -13.5 ●13.5×13.5	¥2,900
0903 2015 -15 ●15×15	¥3,450
0903 2016 -16.5 ●16.5×16.5	¥4,300
0903 2018 -18 ●18×18	¥4,900
0903 2021 -21 ●21×21	¥5,450



0901 1020 0901 1025 0901 1010

SAUCE CONTAINER
タレ入れ/ポリカーボネイト

0901 1020 台無し	¥3,200
0901 1025 台無し(ハケ置無し) ●9.5×9.5×H8.2 (cm)	¥2,900
0901 1010 台付	¥3,500
0901 1015 台付(ハケ置無し) ●9.5×9.5×H9 ●耐熱温度:120℃ ●材質:POLYCARBONATE	¥3,200



CONDIMENT TRAY
薬味入用トレイ

0901 0843 -3 ●30×10.7 (cm)	¥1,750
0901 0842 -2 ●21×10.7 ●7cm8cm薬味入兼用	¥1,750



CONDIMENT HOLDER
薬味入D/本体切欠付

0901 1270-L ●10.7×10.7×H15 (cm) ●1,200 (c.c.)	¥2,500
0901 1260-M ●10.7×10.7×H11 ●900	¥2,100
0901 1250-S ●10.7×10.7×H8.5 ●600	¥1,900
●材質:MS	

スタッキング
できます。

CONDIMENT POT
薬味入D/角KPフタ付

0901 1220-L ●10.7×10.7×H15 (cm)	¥2,700
0901 1210-M ●10.7×10.7×H11	¥2,300
0901 1200-S ●10.7×10.7×H8.5	¥2,100
●材質:MS	



CONDIMENT HOLDER
薬味入 C

0901 1120-L ●10.7×10.7×H15 (cm) ●1,200 (c.c.)	¥2,500
0901 1110-M ●10.7×10.7×H11 ●900	¥2,400
0901 1150-L (切欠きなし) ●10.7×10.7×H15 ●1,200	¥2,400
0901 1140-M (切欠きなし) ●10.7×10.7×H11 ●900	¥2,300
●材質:MS ※なくなり次第廃番です。	



CONDIMENT HOLDER
薬味入

0901 1195-A ●7.7×7.7×H7.5 (cm) ●POLYCARBONATE+ST.STフタ	¥1,980
0901 1196-B ●7.7×7.7×H9 ●POLYCARBONATE+MSフタ	¥1,350
0901 1168 -トレーのみ ●19×11 ●材質:MS	¥600



CONTAINER/ROUND
丸キッチンポット/割蓋付

0907 2054 ●14φ×H14 (cm) ●1,800 (c.c.) ●材質:POLYCARBONATE	¥3,500
--	--------



CONDIMENT JAR
薬味入/アクリル蓋付

0901 1370 ●9φ×H11.5 (cm) ●330 (c.c.)	¥1,150
--	--------

NEW

CONDIMENT JAR
薬味入

0901 1400 ●8.1φ×H10.8 (cm) ●270 (c.c.) ●材質:POLYCARBONATE+ST.STフタ	¥3,000
---	--------



(切欠きなし)

CONDIMENT JAR
薬味入

0901 1300-9 (本体切欠きなし) ●9φ×H8 (cm) ●330 (c.c.)	¥1,750
0901 1340-8 ●8φ×H7.5 ●230 ●材質:MS+ST.STフタ	¥1,700



CONDIMENT JAR
薬味入

0901 1330-11 ●11φ×H8 (cm) ●410 (c.c.)	¥1,900
0901 1320-8.6 ●8.6φ×H6.5 ●190 ●材質:MS+ST.STフタ	¥1,850



丸・深型キッチンポット/カラープレート付

SIZE	商品コード				価格
	レッド	ブルー	イエロー	グリーン	
12cm	0967 4120	0967 4123	0967 4126	0967 4129	¥3,850
14	0967 4140	0967 4143	0967 4146	0967 4149	¥4,500
16	0967 4160	0967 4163	0967 4166	0967 4169	¥5,400
18	0967 4180	0967 4183	0967 4186	0967 4189	¥6,620

●価格はカラープレート2枚付です。

CANISTER/DEEP

丸・深型キッチンポット/目盛付 18-8 ST.ST

0967 0080-8cm	¥1,550
●8φ×H8(cm) ●約0.4(ℓ)	
0967 0090-9	¥1,700
●9φ×H9 ●約0.58	
0967 0100-10	¥2,150
●10φ×H10 ●約0.7	
0967 0110-11	¥2,700
●11φ×H11 ●約1	
0967 0120-12	¥2,750
●12φ×H12 ●約1.3	
0967 0130-13	¥3,300
●13φ×H13 ●約1.7	
0967 0140-14	¥3,350
●14φ×H14 ●約2.1	
0967 0150-15	¥4,200
●15φ×H15 ●約2.6	
0967 0160-16	¥4,250
●16φ×H16 ●約3.2	
0967 0170-17	¥5,350
●17φ×H17 ●約3.8	
0967 0180-18	¥5,450
●18φ×H18 ●約4.5	
0967 0190-19	¥6,400
●19φ×H19 ●約5.3	
0967 1200-20(手付)	¥6,500
●20φ×H20 ●約6	
0967 1210-21(手付)	¥7,300
●21φ×H21 ●約7.2	
0967 1220-22(手付)	¥7,400
●22φ×H22 ●約8	
0967 1240-24(手付)	¥9,600
●24φ×H24 ●約11	
0967 1260-26(手付)	¥11,000
●26φ×H26 ●約13	
0967 1280-28(手付)	¥14,500
●28φ×H28 ●約16	
0967 1300-30(手付)	¥16,900
●30φ×H30 ●約21	
0967 1330-33(手付)	¥24,800
●33φ×H33 ●約28	

※8cm・9cmの蓋には引掛けは付いていません。

CANISTER/DEEP

丸・深型キッチンポット

抗菌

0977 0080-8cm	¥1,480
0977 1260-26	¥9,900
0977 1280-28	¥13,800
0977 1300-30	¥15,800

※なくなり次第廃番です。

CANISTER/DEEP

丸・深型キッチンポット/目盛付 21-0 ST.ST

0969 1210-21cm(手付)	¥5,900
●21φ×H21(cm) ●約7.2(ℓ)	
0969 1330-33(手付)	¥19,800
●33φ×H33 ●約28	

※なくなり次第廃番です。



CANISTER/SHALLOW
丸・浅型キッチンポット

0906 0090-9cm	¥1,450
●9φ×H5(cm) ●約0.3(ℓ)	
0906 0100-10	¥1,600
●10φ×H5.5 ●約0.45	
0906 0120-12	¥1,900
●12φ×H6.5 ●約0.8	
0906 0140-14	¥2,300
●14φ×H7.5 ●約1.2	
0906 0160-16	¥2,800
●16φ×H8.5 ●約1.8	
0906 0180-18	¥3,250
●18φ×H9.5 ●約2.5	



LID FOR CANISTER
丸キッチンポット用割蓋

0907 2014-14cm	¥3,300
●14φ(cm)	
0907 2016-16	¥3,500
●16φ	
0907 2018-18	¥3,800
●18φ	
0907 2020-20	¥4,400
●20φ	



STOCK POT
寸胴鍋(手付)

0926 0270-27cm	¥15,500
●27φ×H27(cm) ●約15(ℓ)	
0926 0300-30	¥17,200
●30φ×H30 ●約20	
0926 0330-33	¥23,700
●33φ×H33 ●約28	

※なくなり次第廃番です。



STOCK POT
半寸胴鍋(手付)

0926 2270-27cm	¥14,000
●27φ×H18(cm) ●約10(ℓ)	
0926 2300-30	¥17,900
●30φ×H19 ●約13	
0926 2330-33	¥20,500
●33φ×H22 ●約18	
0926 2360-36	¥25,000
●36φ×H24 ●約24	
0926 2390-39	¥31,000
●39φ×H25 ●約30	

※なくなり次第廃番です。

FOOD STORAGE PANS (ST.ST.PC)



FOOD STORAGE PAN/DEEP/OBLONG
深型バット

0990 3300 2枚取	¥34,000
●64.0×42.0×H18 (cm)	
0990 3303 3	¥32,100
●58.0×42.0×H14	
0990 3304 4	¥28,400
●58.0×37.0×H12	
0990 3306 6	¥11,000
●47.7×33.2×H11	
0990 3308 8	¥8,900
●40.8×29.5×H10.5	
0990 3310 10	¥7,900
●36.2×27.8×H10	
0990 3312 12	¥6,200
●33.0×26.2×H9.3	
0990 3315 15	¥5,100
●29.4×23.0×H8.5	
0990 3321 21	¥4,100
●25.0×20.5×H8	
0990 3350 キャビネット判	¥3,900
●21.5×17.5×H7.8	



FOOD STORAGE PAN/DEEP/OBLONG
野菜水切りバット

0990 3200 2枚取	¥35,000
●64.0×42.0×H18 (cm)	
0990 3203 3	¥32,500
●58.0×42.0×H14	
0990 3204 4	¥29,000
●58.0×37.0×H12	
0990 3206 6	¥13,500
●47.7×33.2×H11	
0990 3208 8	¥11,600
●40.8×29.5×H10.5	
0990 3210 10	¥9,800
●36.2×27.8×H10	
0990 3212 12	¥7,800
●33.0×26.2×H9.3	
0990 3215 15	¥6,900
●29.4×23.0×H8.5	
0990 3221 21	¥5,400
●25.0×20.5×H8	
0990 3250 キャビネット判	¥4,900
●21.5×17.5×H7.8	
●4.0φ	

※2枚取のみ足だし(ポチ出し)加工していません。

●OPTIONAL ハンドル付



ワイヤーハンドル
¥1,700 SET



プレートハンドル
¥2,000 SET



●OPTIONAL カラーハンドル付



※取手カラーは4色(赤色・水色・黄色・緑色)ございます。

●シリコン樹脂

シリコンハンドル
¥1,500 SET



HANDLES/FOOD STORAGE PAN
深型バット用ハンドル

2枚取用	¥5,400
3	¥5,400
4	¥5,200

- OPTIONAL ハンドル ●1セット(2本)
- ハンドル2本(取付料込)のみの価格です。
- バットは上記深型バットをご購入ください。
- ST.ST

FOOD CONTAINER BOX
コンテナバット

NEW 0990 3402 3枚取(深型)	¥12,000
●60×40×H20 (cm)	
0990 3403 3	¥11,000
●60×40×H15	
0990 3404 4	¥8,600
●50×35×H15	
0990 3406 6	¥8,000
●45×35×H15	
0990 3408 8	¥6,300
●40×30×H15	
0990 3410 10	¥5,900
●36×27×H15	
●0.65t ●ST.ST	



NEW コンテナバット用蓋

0990 3493 3枚取用	¥4,100
-----------------------	--------



ワイヤーハンドル
¥1,700 SET





FOOD STORAGE PAN/SHALLOW/OBLONG
角パット

0990 0006 6枚取り ●33.6×48.2×H8 (cm)	¥4,750
0990 0008 8 ●29.3×40.6×H6.6	¥3,300
0990 0010 10 ●27.0×35.4×H6	¥2,600
0990 0012 12 ●25.5×32.3×H5.3	¥2,260
0990 0015 15 ●23.3×29.7×H5	¥1,970
0990 0018 18 ●20.8×26.8×H4.3	¥1,670
0990 0021 21 ●20.0×24.7×H3.6	¥1,390
0990 0050 キッチンネット判 ●17.0×21.0×H3.2	¥1,000
0990 0060 カード判 ●14.0×18.5×H2.7	¥900
0990 0070 手札判 ●12.6×15.5×H2.5	¥830



FOOD STORAGE PAN
角パット/カラー取手付

6枚取り ●33.6×48.2×H8 (cm)	●取手サイズ:15.5×2 (cm)	¥6,000
8 ●29.3×40.6×H6.6	●取手サイズ:15.5×2	¥4,650
10 ●27×35.4×H6	●取手サイズ:12.5×1.9	¥3,800
12 ●25.5×32.3×H5.3	●取手サイズ:12.5×1.9	¥3,360
15 ●23.3×29.7×H5	●取手サイズ:12.5×1.9	¥3,000
18 ●20.8×26.8×H4.3	●取手サイズ:9.5×1.8	¥2,730
21 ●20×24.7×H3.6	●取手サイズ:9.5×1.8	¥2,450



※取手カラーは4色(赤色・水色・黄色・緑色)ございます。
●シリコン樹脂

SIZE	商品コード			
	レッド	ブルー	イエロー	グリーン
6枚取り	0990 2210	0990 2220	0990 2230	0990 2240
8	0990 2211	0990 2221	0990 2231	0990 2241
10	0990 2212	0990 2222	0990 2232	0990 2242
12	0990 2213	0990 2223	0990 2233	0990 2243
15	0990 2214	0990 2224	0990 2234	0990 2244
18	0990 2215	0990 2225	0990 2235	0990 2245
21	0990 2216	0990 2226	0990 2236	0990 2246



FOOD STORAGE PAN PERFORATED
穴付角パット

0990 4986 6枚取 ●33.8×48.2×H8 (cm)	¥5,950
0990 4988 8 ●29.5×41×H6.7	¥4,600
0990 4990 10 ●27×35.5×H6.3	¥3,300
0990 4992 12 ●26×32.5×H5.3	¥3,100



P.C FOOD PAN
P.C 角パット

0990 2976 6枚取 ●48×34×H8 (cm)	¥3,600
0990 2978 8 ●41×30×H6.5	¥3,100
0990 2980 10 ●36×28×H6.3	¥2,300
0990 2982 12 ●32×25×H5.4	¥2,000
0990 2985 15 ●30×24×H5.2	¥1,750
0990 2988 18 ●27×21×H4.7	¥1,550
●材質:POLYCARBONATE	



FOOD STORAGE PAN/SHALLOW
浅型バット

0990 1906	6枚取り	¥4,300
●33.8×48.2(cm)		
0990 1908	8	¥3,100
●29.5×41		
0990 1910	10	¥2,450
●27×35.5		
0990 1912	12	¥2,250
●26×32.5		
0990 1915	15	¥1,900
●23.2×29.7		
0990 1918	18	¥1,650
●20.6×26.7		



FOOD STORAGE PAN/CAKE
ケーキバット

0990 1508	8吋	¥690
●14.0×20.0×H1.5(cm)		
0990 1509	9	¥790
●15.5×22.0×H1.5		
0990 1510	10	¥920
●17.5×26.0×H1.6		
0990 1511	11	¥1,070
●20.5×28.5×H1.7		
0990 1512	12	¥1,310
●23.0×32.0×H1.8		
0990 1514	14	¥1,590
●25.0×35.0×H1.9		
0990 1515	15	¥1,950
●28.5×38.5×H2.1		
0990 1516	16	¥2,340
●30.5×41.5×H2.1		
0990 1517	17	¥3,040
●32.0×43.5×H2.1		
0990 1518	18	¥3,480
●34.5×46.5×H2.2		
●18-0 ST.ST		



FOOD STORAGE PAN/ PERFORATED
水切りバット

0990 3106	6枚取り	¥6,300
●33.8×48.2(cm)		
0990 3108	8	¥4,600
●29.5×41		
0990 3110	10	¥3,400
●27×35.5		
0990 3112	12	¥3,100
●26×32.5		
0990 3115	15	¥2,700
●23.2×29.7		
0990 3118	18	¥2,400
●20.6×26.7		



BAKING SHEET
シートトレイ

0998 9088 〈大〉		¥6,750
●65.3×45.3×H3(cm)		
0998 9089 〈小〉		¥6,100
●55.0×45.3×H3		
●18-0 ST.ST		





FOOD STORAGE PAN/DEEP/OBLONG
深型組バット

0990 1000 0号	¥900
●10.6×13.5×H5.7 (cm)	
0990 1005 S	¥1,470
●11.0×16.0×H6.5	
0990 1010 1	¥1,580
●12.3×18.5×H6.6	
0990 1020 2	¥1,800
●14.0×19.5×H7.2	
0990 1030 3	¥2,100
●15.4×21.5×H7.5	
0990 1040 4	¥2,230
●17.3×23.0×H7.3	
0990 1050 5	¥2,600
●18.8×27.0×H8	
0990 1060 6	¥3,800
●20.3×30.0×H8.2	
0990 1070 7	¥4,400
●23.0×33.0×H8.5	
0990 1080 8	¥4,800
●24.3×35.0×H8.7	
0990 1090 9	¥5,150
●26.0×36.5×H9	
0990 1100 10	¥7,100
●28.3×40.5×H9.3	
0990 1110 11	¥8,300
●31.3×43.0×H9.6	
0990 1120 12	¥10,900
●34.2×47.4×H11.2	
0990 1130 13	¥13,600
●37.2×51.2×H12.2	



FOOD STORAGE PAN/DEEP
深型組バット用蓋

0990 1205 S号	¥710
●11.5×16.7 (cm)	
0990 1210 1	¥780
●13.0×19	
0990 1220 2	¥830
●14.5×20.2	
0990 1230 3	¥970
●16.0×22	
0990 1240 4	¥1,250
●18.0×23.6	
0990 1250 5	¥1,470
●19.5×27.6	
0990 1260 6	¥1,850
●21.0×30.6	
0990 1270 7	¥2,080
●23.5×33.5	
0990 1280 8	¥2,270
●24.7×35.6	
0990 1290 9	¥2,500
●26.5×37	
0990 1300 10	¥3,050
●29.0×41	



FOOD STORAGE PAN
餃子バット

0990 0735 〈小・蓋〉	¥2,350
●34.7×26.5×H1.2 (cm)	
0990 0730 〈小・身〉	¥4,600
●33.5×26.0×H5	
0990 0715 〈大・蓋〉	¥2,750
●42.0×31.3×H1.2	
0990 0710 〈大・身〉	¥5,250
●40.0×30.0×H5	
0990 0705 〈特大・蓋〉	¥3,650
●49.0×37.0×H1.2	
0990 0700 〈特大・身〉	¥6,750
●47.0×36.0×H5	
●18-8 ST.ST	



FOOD STORAGE PAN/SHALLOW/SQUARE
正角バット

0993 0006 6枚取	¥6,750
●33.4×33.4×H8.2 (cm)	
0993 0008 8	¥5,550
●29.5×29.5×H6.8	
0993 0010 10	¥4,270
●27.0×27.0×H6.4	
0993 0012 12	¥4,000
●25.9×25.9×H5.3	
0993 0015 15	¥3,650
●23.4×23.4×H5	
0993 0018 18	¥2,850
●20.7×20.7×H4.3	
0993 0021 21	¥2,550
●20.0×20.0×H3.8	
0993 0050 キャビネット判	¥2,000
●16.8×16.8×H2.8	





CONDIMENT HOLDER

調味料入バット(中子なし)P.C蓋付 0号

0990 0305 (3個入用) セット	¥8,150
0990 0306 (3個入用) ケース(金具付)	¥5,650
0990 0307 (3個入用) P.C蓋のみ	¥2,500
0990 0310 (4個入用) セット	¥9,300
0990 0311 (4個入用) ケース(金具付)	¥6,200
0990 0312 (4個入用) P.C蓋のみ	¥3,100

※調味料入(中子)0号は別売りです。

調味料入(中子)0号

0990 1000	¥900
-----------	------

●10.6×13.5×H5.7 (cm)



抗菌 INSERT for CONDIMENT HOLDER
調味料入(中子)0号

0989 1000	¥1,750
-----------	--------

●10.6×13.5×H5.7 (cm)



OBLONG CANISTER/W/LID
調味料入 フタ付(PE)0号

0990 1400	¥990
-----------	------

●14.7×11.7 (cm)
●POLYETHYLENE



スタッキング
できます



バット側蓋取り付け部の開口部にクリア蓋の支柱端の上部を合わせて片側から挿入します。



この場合、蓋を垂直に立て斜めに挿入して下さい。



片側を挿入したら水平に戻し反対端部を平行移動して挿入します。



装着完了。※脱取りはずしはこの手順の逆となります。



CONDIMENT HOLDER/W/INSERT
調味料入バット(中子付)0号

0990 0320 (2個入)	¥4,300
●14.5×22.5×H6 (cm)	
0990 0330 (3個入)	¥6,000
●14.5×33.0×H6	
0990 0340 (長4個入)	¥7,700
●14.5×43.5×H6	
0990 0345 (角4個入)	¥7,700
●22.5×28.5×H6	
0990 0350 (長5個入)	¥9,600
●14.5×54.3×H6	
0990 0360 (角6個入)	¥10,900
●28.5×33.0×H6	
●ケース ST.ST ●0号 18-8 ST.ST	

CONDIMENT HOLDER/WO/INSERT
調味料入バット(中子なし)0号

0990 0321 (2個入)	¥2,500
●14.5×22.5×H6 (cm)	
0990 0331 (3個入)	¥3,300
●14.5×33.0×H6	
0990 0341 (長4個入)	¥4,100
●14.5×43.5×H6	
0990 0346 (角4個入)	¥4,100
●22.5×28.5×H6	
0990 0351 (長5個入)	¥5,100
●14.5×54.3×H6	
0990 0361 (角6個入)	¥5,500
●28.5×33.0×H6	
●ケース ST.ST	



PIZZA PEEL
ピザピール

0923 0190 ●33×全長176 (cm)	¥13,500
0923 0192 ●36×全長185	¥15,500
0923 0194 ●40×全長190 ●ALUMINUM ●硫酸アルマイト(内・外面)	¥17,500



PIZZA PEEL
アルミバラ

0923 0205 ●36×全長187 (cm) ●材質: アルミニウム+ST.ST *木柄(スライド式)はオプションです。	¥35,400
--	---------



PIZZA PEEL
ピザピール

0923 0218-18cm (穴無) ●18φ (cm)	¥21,600
0923 0220-20 (穴無) ●20φ	¥22,200
0923 0222-22 (穴無) ●22φ	¥23,400
0923 0224-24 (穴無) ●24φ	¥24,600
0923 0226-26 (穴無) ●26φ	¥25,200
0923 0318-18 (穴付) ●18φ	¥22,200
0923 0320-20 (穴付) ●20φ	¥22,500
0923 0322-22 (穴付) ●22φ	¥23,700
0923 0324-24 (穴付) ●24φ	¥25,200
0923 0326-26 (穴付) ●26φ	¥25,900

Handle: 160 (cm)
*特注サイズも出来ます。

PIZZA PEEL RACK (ST.ST)



※ピザピールは別売りです。

PIZZA PEEL
ピザピール/アングル付

0923 0418	18cm (穴無)	¥22,200
0923 0420	20 (穴無)	¥22,800
0923 0422	22 (穴無)	¥24,000
0923 0424	24 (穴無)	¥25,200
0923 0426	26 (穴無)	¥26,400

●受注生産

PIZZA PEEL
ピザピール/ソバ付

0923 0518	18cm (穴無)	¥26,600
0923 0520	20 (穴無)	¥27,200
0923 0522	22 (穴無)	¥28,400
0923 0524	24 (穴無)	¥29,600
0923 0526	26 (穴無)	¥31,000

●受注生産

PIZZA PEEL RACK
ピザピールラック

0923 0900	¥69,900
-----------	---------

●受注生産

KITCHEN UTENSIL



CLEANING SCRAPER
油・ゴミ取り

0925 3295	¥9,370
-----------	--------

●5×20 (cm) Handle:97 (cm)

PIZZA RAKE
ピザオープン用レーキ

0925 3293	¥19,800
-----------	---------

●頭部:5×31 (cm) 全長:170 (cm)

PIZZA SCOOP
ピザオープン用スコップ

0925 3297	¥28,000
-----------	---------

●頭部:21.5×31×H5 (cm)
全長:183.5 (cm)

CLEANING COLANDER
ヘッドロキャッチャー

0925 3291-L	¥36,700
●24×18×H8.5 (cm) 全長:126 (cm)	
0925 3290-S	¥32,800
●18.5×6.5×H10 全長:130	
●handle:120 (cm) 1.2t 3.0φ	



ROUND BLADE PEEL
ピザサーバー

0923 0620 ● 20φ × 35 (cm)	¥ 3,000
0923 0625 ● 25φ × 40	¥ 3,550
0923 0630 ● 30φ × 45 ● ST.ST	¥ 4,100



ROUND BLADE PEEL
ピザサーバー

0923 0605 ● 20φ × 35 (cm)	¥ 3,650
0923 0610 ● 25φ × 40	¥ 4,200
0923 0615 ● 30φ × 45 ● ALUMINUM	¥ 5,200



PIZZA LIFTER W/STOPPER
ピザサーバー ストッパー付

0923 0640 ● 20φ × 35 (cm)	¥ 3,100
0923 0642 ● 25φ × 40	¥ 5,100
0923 0644 ● 30.5φ × 45 ● ST.ST	¥ 5,800



PIZZA PEEL
ピザピール・丸

0923 0211 -20cm	¥ 13,800
● 20φ (cm) Handle:96 (cm)	



PIZZA PEEL
ピザピール・角

0923 0210	¥ 14,900
● 31 × 31 (cm) Handle:95 (cm)	



PIZZA PEEL
ピザピール・長方形

0923 0209	¥ 17,900
● 37.5 × 25.5 (cm) Handle:95 (cm)	



PIZZA TURNER
ピザピール・丸

0923 0214 -26cm	¥ 9,360
● 26φ (cm) Handle:25 (cm)	
0923 0215 -28	¥ 9,460
● 28φ Handle:25	



PIZZA SERVER
ピザサーバー

0923 0600	¥ 6,790
● 18φ × 37 (cm)	



PIZZA TURNER
ピザターナー

0913 1210	¥ 3,280
● 19.5 × 15 (cm) Handle:19 (cm)	
● 18-0 ST.ST	



PIZZA PEELS
ピザピール/アルミニウム

0923 0660 -66cm	¥5,800
●30.5×33.5 (cm)	
0923 0662 -90	¥6,100
●30.5×33.5	
0923 0664 -115	¥6,400
●30.5×33.5	
0923 0666 -133	¥6,950
●30.5×33.5	
●ALUMINUM	



PIZZA PEELS
ピザピール/アルミニウム

0923 0650 -60cm	¥4,950
●30φ (cm)	
0923 0652 -84	¥5,250
●30φ	
0923 0654 -109	¥5,650
●30φ	
0923 0656 -127	¥6,100
●30φ	
●ALUMINUM	



PIZZA BOARD
サービングボード

0923 0670	¥2,550
●30.5×33×56 (cm)	
0923 0672	¥2,850
●33.5×41×56	
●BEECH WOOD (ブナ)	



PIZZA BOARD
サービングボード

0923 0680	¥2,800
●25φ×56 (cm)	
0923 0682	¥3,550
●36φ×56	
●BEECH WOOD (ブナ)	



PIZZA BOARD
ガトーリフタ

0923 0691	¥6,380
●26×31 (cm)	
●18-8 ST.ST	



PIZZA BOARD
パイリフタ

0923 0690	¥6,380
●26×35 (cm)	
●18-8 ST.ST	



PIZZA ROCKER
ピザカッター

0923 0980 (L) ¥2,400
●44.5×11 (cm)
●18-0 ST.ST



PIZZA ROCKER
ピザカッター

0923 0981 (S) ¥1,950
●35×9 (cm)
●18-0 ST.ST



PIZZA TURNER
ピザターナー

0923 0990 ¥1,750
●全長27 (cm)
●ST.ST (420) +PP



OVEN BRUSH SCRAPER
オーブンブラシ/スクレイパー

0923 0960 ¥7,000
●40×100 (cm)

0923 0961 ブラシ ¥4,400

PIZZA BUBBLE POPPER
ピザバブルポッパー

0923 0950 ¥3,900
●86 (cm)



PIZZA RACK
ピザラック

0923 0800 ¥8,800
●37×22×H26 (cm)
●ST.ST
※プレートはイメージです。



PIZZA PEEL RACK
ピザピールラック

0923 0910 -S ¥102,000
●60×35×158 (cm)

0923 0920 -L ¥103,000
●60×35×183
※ピザピールは別売りです。

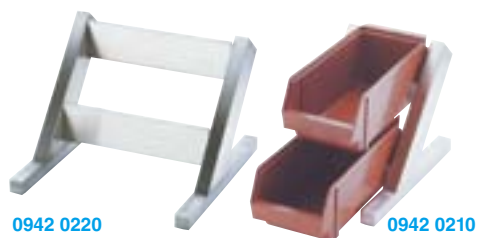

0942 0220

0942 0210

ORGANIZER/W/O BOX
オーガナイザー/ボックス無し

- | | |
|------------------------|---------|
| 0942 0210 —2段1列 | ¥27,700 |
| ●18×44×23 (cm) | |
| 0942 0220 —2段2列 | ¥28,300 |
| ●31×44×23 | |
| ●18-8 ST.ST | |

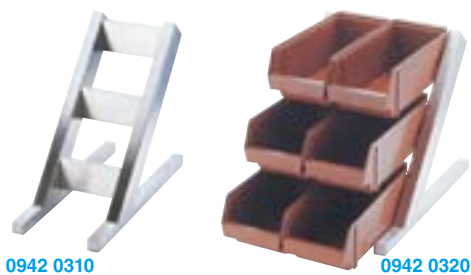

0942 0310

0942 0320

ORGANIZER/W/O BOX
オーガナイザー/ボックス無し

- | | |
|------------------------|---------|
| 0942 0310 —3段1列 | ¥28,500 |
| ●18×55×35 (cm) | |
| 0942 0320 —3段2列 | ¥29,900 |
| ●31×55×35 | |
| ●18-8 ST.ST | |



0942 0240

0942 0230

ORGANIZER/W/O BOX
オーガナイザー/ボックス無し

- | | |
|------------------------|---------|
| 0942 0230 —2段3列 | ¥29,900 |
| ●43×44×23 (cm) | |
| 0942 0240 —2段4列 | ¥34,600 |
| ●56×44×23 | |
| ●18-8 ST.ST | |



0942 0330

0942 0340

ORGANIZER/W/O BOX
オーガナイザー/ボックス無し

- | | |
|------------------------|---------|
| 0942 0330 —3段3列 | ¥37,400 |
| ●43×55×35 (cm) | |
| 0942 0340 —3段4列 | ¥44,300 |
| ●56×55×35 | |
| ●18-8 ST.ST | |



抗菌 ORGANIZER BOX/ANTIBACTERIAL
オーガナイザー ボックス

- | | |
|--------------------|------|
| 0942 0200 | ¥900 |
| ●12.7×30×10.7 (cm) | |
| ●PP (ポリプロピレン) | |





0918 0010 0918 0020 0918 0030

**DREDGER/S-SIZE/
W/PLASTIC COVER**
フタ付調味缶(小)

- 0918 0010 (S) SALT
- 0918 0020 (P) PEPPER
- 0918 0030 (A) AJI-NO-MOTO
- 5.5φ × H7.5 (cm)

各 ¥1,100



0918 1010 0918 1020 0918 1030 0918 1040 0918 1050 0918 1060 0918 1090

DREDGER/L-SIZE
調味缶(大)

- 0918 1010 (S) SALT
- 0918 1020 (P) PEPPER
- 0918 1030 (A) AJI-NO-MOTO
- 0918 1040 (G) GOMA (SESAME)
- 0918 1050 (N) NORI
- 0918 1060 (F) FURIKAKE
- 0918 1090 (穴なし)
- 7φ × H9 (cm)

各 ¥1,200



0918 2010 0918 2020 0918 2030 0918 2040 0918 2050 0918 2060 0918 2090

DREDGER/LM-SIZE
調味缶(特中)

- 0918 2010 (S) SALT
- 0918 2020 (P) PEPPER
- 0918 2030 (A) AJI-NO-MOTO
- 0918 2040 (G) GOMA (SESAME)
- 0918 2050 (N) NORI
- 0918 2060 (F) FURIKAKE
- 0918 2090 (穴なし)
- 7φ × H13.5 (cm)

各 ¥2,500



0918 3010 0918 3020 0918 3030 0918 3040 0918 3050 0918 3060 0918 3090

DREDGER/LL-SIZE
調味缶(特大)

- 0918 3010 (S) SALT
- 0918 3020 (P) PEPPER
- 0918 3030 (A) AJI-NO-MOTO
- 0918 3040 (G) GOMA (SESAME)
- 0918 3050 (N) NORI
- 0918 3060 (F) FURIKAKE
- 0918 3090 (穴なし)
- 7φ × H17.5 (cm)

各 ¥3,150



0918 5010 0918 5020 0918 5030 0918 5040 0918 5050

**DREDGER/LONG-SIZE/
W/PLASTIC COVER**
蓋付調味缶小(ロング)

- 0918 5010 (S) SALT
- 0918 5020 (P) PEPPER
- 0918 5030 (A) AJI-NO-MOTO
- 0918 5040 (G) GOMA (SESAME)
- 0918 5050 (N) NORI
- 5.5φ × H11.5 (cm)

各 ¥1,950



S (2φmm)



P (1φmm)



A (2φmm)



G (4φmm)



N (6φmm)



F (4φmm)



※このカラーはイメージ画像です。



PC.DREDGER/L-SIZE
調味缶(大)/ポリカーボネイト

- 0919 2010 〈S〉 SALT
- 0919 2020 〈P〉 PEPPER
- 0919 2030 〈A〉 AJI-NO-MOTO
- 0919 2040 〈G〉 GOMA (SESAME)
- 0919 2050 〈N〉 NORI
- 0919 2060 〈F〉 FURIKAKE
- 7.5φ × H9 (cm) 各 ¥1,100
- 0919 2070 〈シュガー〉 SUGAR
- 7.5φ × H10.2 ¥1,150
- POLYCARBONATE



PC.DREDGER/S-SIZE
調味缶(小)/ポリカーボネイト

- 0919 0010 〈S〉 SALT
- 0919 0020 〈P〉 PEPPER
- 0919 0030 〈A〉 AJI-NO-MOTO
- 5.7φ × H7.5 (cm) 各 ¥870
- 0919 0040 〈シュガー〉 SUGAR ¥940
- 5.7φ × H8.2
- POLYCARBONATE



DREDGER
調味缶

- 0918 0100 ¥1,300
- 5.5φ × H6.5 (cm)



0919 3120



0919 3100

DREDGER/MESH COVER
パウダー缶

- 0919 3120 L ¥1,800
- 7φ × H9.5 (cm)
- 0919 3100 S ¥1,700
- 5.5φ × H7.5
- 32メッシュ・0.14 (mm)

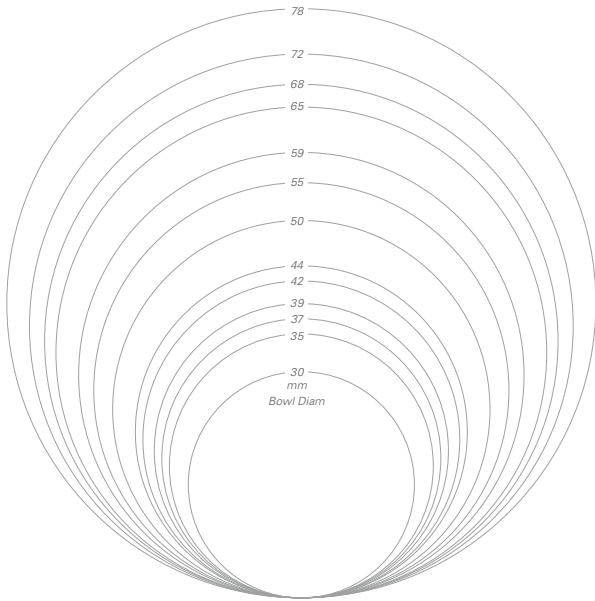

S-TYPE DISHER
S型ディッシャー

0914 0060 - # 6	● Bowl Diam: 7.8 (cm) ● 130 (c.c.)	¥ 3,470
0914 0080 - # 8	● Bowl Diam: 7.2 ● 110	¥ 3,470
0914 0100 - # 10	● Bowl Diam: 6.8 ● 90	¥ 3,100
0914 0120 - # 12	● Bowl Diam: 6.5 ● 80	¥ 3,100
0914 0140 - # 14	● Bowl Diam: 5.9 ● 60	¥ 3,100
0914 0160 - # 16 (バレル仕様)	● Bowl Diam: 5.5 ● 50	¥ 3,100
0914 0180 - # 18 (バレル仕様)	● Bowl Diam: 5 ● 35	¥ 3,100
0914 0200 - # 20 (バレル仕様)	● Bowl Diam: 4.4 ● 25	¥ 3,100
0914 0220 - # 22 (バレル仕様)	● Bowl Diam: 4.2 ● 20	¥ 3,100
0914 0240 - # 24 (バレル仕様)	● Bowl Diam: 3.9 ● 18	¥ 3,100
0914 0260 - # 26 (バレル仕様)	● Bowl Diam: 3.7 ● 16	¥ 3,100
0914 0270 - # 27 (バレル仕様)	● Bowl Diam: 3.5 ● 12	¥ 3,100
0914 0280 - # 28 (バレル仕様)	● Bowl Diam: 3 ● 8	¥ 3,100

E-TYPE DISHER
スーパーディッシャー<E型>

0916 3010 - # 10	● Bowl Diam: 6.5 (cm) ● 90 (c.c.)	¥ 2,250
0916 3012 - # 12	● Bowl Diam: 6.3 ● 80	¥ 2,250
0916 3014 - # 14	● Bowl Diam: 5.9 ● 60	¥ 2,200
0916 3016 - # 16	● Bowl Diam: 5.5 ● 50	¥ 2,200
0916 3018 - # 18	● Bowl Diam: 5 ● 35	¥ 2,200
0916 3020 - # 20	● Bowl Diam: 4.4 ● 25	¥ 2,200
0916 3022 - # 22	● Bowl Diam: 4.2 ● 20	¥ 2,200
0916 3024 - # 24	● Bowl Diam: 3.9 ● 18	¥ 2,200

● 修理不可能です。 MADE IN CHINA

B-TYPE DISHER/LEMON TYPE
B型ディッシャー<レモン> バレル仕様

0915 0160 - # 16	● Bowl Diam: 6.7 × 5.2 (cm) ● 60 (c.c.)	¥ 4,380
0915 0180 - # 18	● Bowl Diam: 6.2 × 4.7 ● 40	¥ 4,380
0915 0200 - # 20	● Bowl Diam: 5.5 × 4.1 ● 30	¥ 4,380



ICE CREAM BOLLER ST/ST
アイスクリームボーラー

0917 0060 - #16 ¥5,450
●4.7×18 (cm)
●18-8 ST.ST



ICE CREAM SERVER
アイスヘラ

0917 2030 - (L) ¥4,650
●32 (cm)
0917 2020 - (M) ¥4,350
●29
0917 2010 - (S) ¥4,100
●26



ICE CREAM BOLLER
アイスクリームボーラー

0917 0140 - #14 ¥5,850
●4.7×18.5 (cm)
0917 0160 - #16 ¥5,850
●4.7×18
0917 0180 - #18 ¥5,850
●4.3×17.5
●ALUMINUM



ICE CREAM SCOOPER
アイスクリームスクーパー

0917 1010 ¥6,600
●7×22 (cm)
●ALUMINUM



ICE CREAM SERVER
アイスヘラ

0917 1030 ¥2,100
●27×7 (cm)
●シリコンハンドル付



ICE SCOOP
シャーベツトスプーン

0917 3010 ¥2,200
●25.3×6.6 (cm)
※なくなり次第廃番です。



ICE CREAM SERVER
アイスクリームサーバー

0917 4010 - (L) ¥1,200
●21×4.8 (cm)
0917 4020 - (S) ¥720
●15.5×3.5





Option



※追加料金でレードルに取り付けができます。

COLOR MARKER
レードル カラー マーカー

RED	¥330
BLUE	¥330
YELLOW	¥330
GREEN	¥330
●P.P	

KITCHEN
UTENSIL



ONE PIECE LADLE
ワンピースレードル

0909 0000-5 c.c. ●3.6φ (cm) Handle:23 (cm)	¥1,130	0909 0010-70 ●7.0φ Handle:24	¥1,700
0909 0001-10 ●3.8φ Handle:23	¥1,180	0909 0011-80 ●7.5φ Handle:24	¥1,780
0909 0002-15 ●4.6φ Handle:23	¥1,200	0909 0012-90 ●7.6φ Handle:24.5	¥1,850
0909 0003-20 ●4.6φ Handle:23	¥1,220	0909 0013-100 ●7.9φ Handle:24.5	¥1,900
0909 0004-25 ●5.3φ Handle:23	¥1,250	0909 0014-120 ●8.3φ Handle:24.5	¥1,950
0909 0005-30 ●5.5φ Handle:23	¥1,350	0909 0015-144 ●9.0φ Handle:28	¥2,050
0909 0006-36 ●5.5φ Handle:23	¥1,400	0909 0016-150 ●9.0φ Handle:28	¥2,100
0909 0007-40 ●6.0φ Handle:23.5	¥1,450	0909 0017-180 ●9.5φ Handle:28	¥2,250
0909 0008-50 ●6.2φ Handle:23.5	¥1,550	0909 0025-270 ●11.0φ Handle:30	¥2,600
0909 0024-54 ●6.3φ Handle:23.5	¥1,580	0909 0021-360 ●11.6φ Handle:30	¥3,000
0909 0009-60 ●6.6φ Handle:23.5	¥1,630		



ONE PIECE POURING LADLE
ワンピース横口レードル

0909 0030-30c.c. ●7.5×5.2 (cm) Handle:22.5 (cm)	¥1,650
0909 0031-50 ●9.7×6.5 Handle:22.5	¥1,800
0909 0032-70 ●10.5×7.0 Handle:24.5	¥1,900
0909 0033-90 ●11.5×7.5 Handle:24.5	¥1,950
0909 0035-144 ●11.5×8.5 Handle:28	¥2,350
0909 0034-180 ●12.0×8.5 Handle:28.5	¥2,600



ONE PIECE LADLE/SHORT HANDLE
ワンピース短柄レードル

0911 9510-10c.c. ●3.8φ (cm) Handle:15 (cm)	¥1,180
0911 9520-20 ●4.6φ Handle:15	¥1,200
0911 9530-30 ●5.5φ Handle:15	¥1,350
0911 9540-40 ●6.0φ Handle:16	¥1,450

ワンピース短柄横口レードル

0911 9620-20c.c. ●7.0×5.0 (cm) Handle:15.4 (cm)	¥1,100
0911 9630-30 ●7.5×5.2 Handle:15.4	¥1,200

SOUP LADLE
スープレードル

0912 0005-5 c.c. ●3.2φ (cm) Handle: 23 (cm)	¥690	0912 0180-180 ●9.4φ Handle: 28	¥1,200
0912 0010-10 ●3.5φ Handle: 23	¥700	0912 0200-200 ●9.5φ Handle: 28	¥1,300
0912 0015-15 ●4.4φ Handle: 23	¥710	0912 0250-250 ●10.2φ Handle: 29	¥1,550
0912 0020-20 ●4.5φ Handle: 23	¥740	0912 0270-270 ●10.8φ Handle: 30	¥1,590
0912 0025-25 ●5.2φ Handle: 23	¥750	0912 0300-300 ●10.8φ Handle: 30	¥1,630
0912 0030-30 ●5.3φ Handle: 23	¥760	0912 0350-350 ●11.4φ Handle: 30	¥1,740
0912 0036-36 ●5.3φ Handle: 23	¥770	0912 0360-360 ●11.4φ Handle: 30	¥1,780
0912 0040-40 ●5.7φ Handle: 23	¥800	0912 0400-400 ●11.9φ Handle: 30	¥1,930
0912 0050-50 ●6.1φ Handle: 23	¥820	0912 0500-500 ●12.9φ Handle: 31	¥2,630
0912 0054-54 ●6.1φ Handle: 23	¥830	0912 0540-540 ●12.9φ Handle: 31	¥2,760
0912 0060-60 ●6.4φ Handle: 23	¥850	0912 0550-550 ●13φ Handle: 31	¥2,800
0912 0070-70 ●6.8φ Handle: 24.5	¥920	0912 0800-800 ●14.9φ Handle: 38	¥3,500
0912 0080-80 ●7.3φ Handle: 24.5	¥950	0912 0900-900 ●15.4φ Handle: 38	¥3,620
0912 0090-90 ●7.6φ Handle: 24.5	¥960	0912 1000-1,000 ●15.8φ Handle: 38	¥3,800
0912 0100-100 ●7.8φ Handle: 24.5	¥1,000	0912 1200-1,200 ●17φ Handle: 38	¥4,200
0912 0120-120 ●8.1φ Handle: 24.5	¥1,100	0912 1800-1,800 ●19.9φ Handle: 47	¥5,700
0912 0144-144 ●8.8φ Handle: 28	¥1,180	0912 2000-2,000 ●20.5φ Handle: 47	¥6,300
0912 0150-150 ●8.8φ Handle: 28	¥1,200		

SOUP LADLE/PIPE HANDLE
スープレードル(パイプハンドル)

0910 0900-900 c.c. ●15.5φ (cm) Handle: 39 (cm)	¥6,700
0910 1000-1,000 ●16φ Handle: 43	¥7,350
0910 1800-1,800 ●20.5φ Handle: 47	¥9,660
0910 2000-2,000 ●21φ Handle: 49	¥11,000

SOUP LADLE/SHORT HANDLE
短柄スープレードル

0911 9005-5 c.c. ●3.3φ (cm) Handle: 15 (cm)	¥690
0911 9010-10 ●3.6φ Handle: 15	¥700
0911 9015-15 ●4.3φ Handle: 15	¥710
0911 9020-20 ●4.5φ Handle: 15	¥740
0911 9025-25 ●5.3φ Handle: 15	¥750
0911 9030-30 ●5.3φ Handle: 15	¥760
0911 9036-36 ●5.3φ Handle: 15	¥770
0911 9040-40 ●5.3φ Handle: 15	¥800
0911 9050-50 ●5.9φ Handle: 15	¥850
0911 9054-54 ●5.9φ Handle: 15	¥860
0911 9060-60 ●5.9φ Handle: 15	¥870
0911 9070-70 ●7.1φ Handle: 15	¥920
0911 9080-80 ●7.2φ Handle: 15	¥950
0911 9090-90 ●7.3φ Handle: 15	¥960
0911 9100-100 ●7.5φ Handle: 15	¥1,000
0911 9120-120 ●7.6φ Handle: 15	¥1,100
0911 9144-144 ●8.9φ Handle: 15	¥1,180
0911 9150-150 ●8.9φ Handle: 15	¥1,200
0911 9180-180 ●9.3φ Handle: 15	¥1,280
0911 9250-250 ●10.2φ Handle: 15	¥1,540

POURING LADLE/SHORT HANDLE
短柄横口レードル

0911 9420-20 c.c. ●5×7 (cm) Handle: 15 (cm)	¥790
0911 9430-30 ●5.2×7.5 Handle: 15	¥810



●エンボスレードル
(ワンピース)

ONE PIECE SOUP LADLE/EMBOSS
スープレードル(エンボス)

0911 0300 —30 c.c.	¥ 1,100
●4.7φ (cm) Handle:23.5 (cm)	
0911 0360 —36	¥ 1,150
●4.7φ Handle:23.5	
0911 0500 —50	¥ 1,200
●6φ Handle:24.5	
0911 0900 —90	¥ 1,350
●6.9φ Handle:31	
0911 3600 —360	¥ 2,600
●11.9φ Handle:31	

※なくなり次第廃番です。



ONE PIECE LADLE/S-TYPE
S型レードル

0909 1036 —36 c.c.	¥ 4,050
●5.3φ (cm) Handle:24.5 (cm)	
0909 1090 —90	¥ 4,830
●7.5φ Handle:29	
0909 1144 —144	¥ 5,250
●8.5φ Handle:30.5	
0909 1180 —180	¥ 5,640
●9.5φ Handle:32	
0909 1270 —270	¥ 6,510
●10.6φ Handle:34	
0909 1360 —360	¥ 7,090
●11.5φ Handle:35.5	



ONE PIECE POURING LADLE/S-TYPE
S型横口レードル

0909 2020	¥ 5,050
●10.5×7 (cm) Handle:29 (cm)	
●約100 (c.c.)	



ONE PIECE OTAMA LADLE/L-SIZE/S-TYPE
S型おたま(L)

0909 2010	¥ 5,170
●9.5φ (cm) Handle:29 (cm)	
●約100 (c.c.)	



ONE PIECE TURNER/S-TYPE
S型ターナー

0909 2030	¥ 4,700
●9×13 (cm) Handle:29 (cm)	



POURING LADLE/LONG-SIZE
 長柄横口レードル

0911 8110 —90c.c.	¥ 1,900
● 7.6×11.4 (cm) Handle:37.8 (cm)	
0911 8111 —144	¥ 2,350
● 7.6×11.4 Handle:37.3	
0911 8112 —180	¥ 3,150
● 7.6×11.4 Handle:37.2	

POURING LADLE
 横口レードル

0913 0500 —50c.c.	¥ 890
● 6.6×9.7 (cm) Handle:23.5 (cm)	
0913 0510 —70	¥ 990
● 6.8×10.3 Handle:25	
0913 0530 —90	¥ 1,110
● 7.6×11.4 Handle:25.5	
0913 0540 —144	¥ 1,440
● 8.4×10.3 Handle:28	
0913 0550 —180	¥ 1,640
● 8.5×12 Handle:28.5	

Option

COLOR MARKER
 レードル カラー マーカー

RED	¥ 330
BLUE	¥ 330
YELLOW	¥ 330
GREEN	¥ 330
● P.P	



※追加料金でレードルに取り付けができます。

POURING LADLE/MINI-SIZE
 ミニ横口レードル

0913 0700 —20c.c.	¥ 790
● 5 × 7 (cm) Handle:22.7 (cm)	
0913 0710 —30	¥ 830
● 5.2×7.5 Handle:23	

BASTING SPOON/MINI-SIZE
 ミニ縦口レードル

0913 0800 —20c.c.	¥ 790
● 5 × 7 (cm) Handle:22.7 (cm)	
0913 0810 —30	¥ 830
● 5.2×7.5 Handle:23	

BASTING SPOON
 縦口レードル

0913 0600 —50c.c.	¥ 940
● 6.6×9.7 (cm) Handle:23.5 (cm)	
0913 0610 —70	¥ 1,020
● 6.8×10.3 Handle:25	

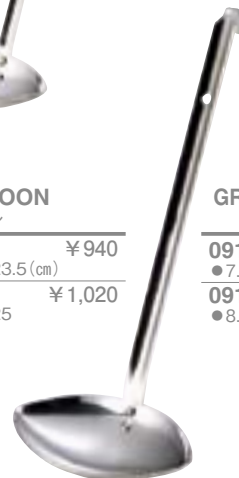
GRAVY LADLE/DOUBLE LIPPED
 両口レードル

0913 0410 —70c.c.	¥ 1,080
● 7.2×12 (cm) Handle:24.5 (cm)	
0913 0420 —180	¥ 1,590
● 8.5×13.9 Handle:24.5	

SKIMMER
 横口スキナー

0913 0906 —20c.c.	¥ 870
● 5 × 7 (cm) Handle:22.7 (cm)	
0913 0907 —30	¥ 910
● 5.2×7.5 Handle:23	
0913 0909 —50	¥ 970
● 6.6×9.7 Handle:23.5	
0913 0910 —70	¥ 1,050
● 6.8×10.3 Handle:25	
0913 0912 —90	¥ 1,200
● 7.6×11.4 Handle:25.5	

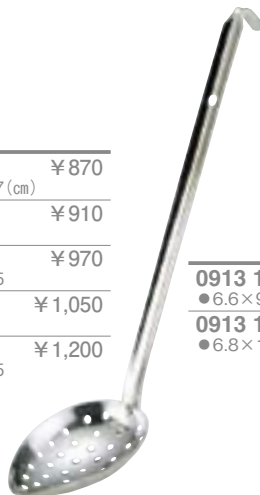
SKIMMER
 縦口スキナー

0913 1009 —50c.c.	¥ 1,000
● 6.6×9.7 (cm) Handle:23.5 (cm)	
0913 1010 —70	¥ 1,080
● 6.8×10.3 Handle:25	



LADLES (ST.ST)

COLOR HANDLE LADLE

カラーハンドルレードル

LADLE/COLOR HANDLE
レードル / カラーハンドル

90 c.c. ●7.5φ (cm) Handle:37 (cm)	¥2,000
144 ●8.8φ Handle:37	¥2,250
180 ●9.4φ Handle:37	¥2,350

横口レードル / カラーハンドル

90 c.c. ●7.5×11.3 (cm) Handle:37 (cm) ●シリコンハンドル カラー ●各色共通価格	¥2,150
--	--------

商品コード				
SIZE	レッド	ブルー	イエロー	グリーン
90c.c.	0911 8121	0911 8122	0911 8123	0911 8124
144	0911 8131	0911 8132	0911 8133	0911 8134
180	0911 8141	0911 8142	0911 8143	0911 8144
横口90	0911 8151	0911 8152	0911 8153	0911 8154



RED BLUE YELLOW GREEN



Option



LADLE W / HOOK
フック付 レードル加工

プラス¥1,500

●追加料金でレードルにフックを取り付けできます。



POURING LADLE
横口レードル

0911 8090—90 c.c. ¥2,000
●7.5×11.3 (cm) Handle:37 (cm)
●シリコンハンドル



LADLE
レードル

0911 8069—90 c.c. ¥1,850
●7.5φ (cm) Handle:37 (cm)
0911 8074—144 ¥2,150
●8.8φ Handle:37



DIPPER
和食タレレードル

0913 1610—90 c.c. ¥1,680
●5.5φ (cm) Handle:40 (cm)
0913 1620—144 ¥1,850
●6.3φ Handle:40

0911 8078—180 ¥2,200
●9.4φ Handle:37
●シリコンハンドル

0913 1630—180 ¥1,980
●7φ Handle:40



0913 0010 0913 0020

OTAMA LADLE
おたま

0913 0010 ¥1,030
●9.5φ (cm) Handle:25.5 (cm)
●約90 (c.c.)



NOODLE LADLE
うどんおたま

0913 0110 ¥1,020
●9φ (cm) Handle:24.5 (cm)
●18-0 ST.ST



0913 1120 0913 1110

SKIMMER/LL-SIZE
特大スキナー

0913 1120 ¥1,180
●11.5φ (cm) Handle:34.5 (cm)



COOKING FORK
コックフォーク

0913 0210 ¥1,050
●9.5×3 (cm) Handle:26 (cm)
●18-0 ST.ST

OTAMA LADLE/PERFORATED
穴明おたま

0913 0020 ¥1,080
●9.5φ (cm) Handle:25.5 (cm)

SKIMMER/L-SIZE
大スキナー

0913 1110 ¥930
●9.5φ (cm) Handle:25.5 (cm)



CAKE TURNER
ケーキターナー

0913 1310 ¥1,280
● 7×16.5(cm) Handle:19.5(cm)



GYOZA TURNER
ぎょうざ返し

0913 1410 ¥1,450
● 7.5×17(cm) Handle:19.5(cm)



TURNER/LL-SIZE
特大ターナー

0913 1520 ¥910
● 9×10.5(cm) Handle:26(cm)



TURNER/L-SIZE
ターナー(L)

0913 1510 ¥850
● 7.5×9(cm) Handle:26(cm)



PIZZA TURNER
ピザターナー

0913 1210 ¥3,280
● 19.5×15(cm) Handle:19(cm)
● 18-0 ST.ST



MESH SKIMMER
パンチメッシュスキナー

0913 1645 ¥4,560
● 14φ(cm) Handle:27.5(cm)



SKIMMER
あく取り

0913 1650 8 cm ¥2,750
● 8.3φ(cm) handle:27.5(cm)
0913 1660 6.5 ¥2,600
● 6.7φ handle:27.5
● 穴径:1.1φ(mm)





SAUCER for NOODLE
ラーメン皿 / B

0995 0360 - 20cm	¥ 320
● 20φ (cm)	
0995 0361 - 22	¥ 380
● 22φ	
● ST.ST 0.2t	



SAUCER for NOODLE
ラーメン皿 / A

0995 0350	¥ 970
● 22.3φ × H2.4 (cm)	
● ST.ST	



EGG/PANCAKE RING
エッグ/パンケーキリング

0995 0210	¥ 1,850
● 10×10 (cm)	



MELON CUTTER
メロンカッター

0920 2050	¥ 25,900
● 20φ × 27 (cm)	



DIPPING BOWL
片口ボール

0920 3300 - 100 c.c.	¥ 940
● 約8.9×7.6×H4.7 (cm)	
0920 3301 - 160	¥ 1,060
● 約10×8.4×H5.3	
0920 3302 - 300	¥ 1,450
● 約12.9×10.5×H6.6	
0920 3303 - 530	¥ 1,950
● 約15×12.4×H7.5	

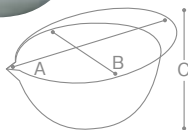

SMALL PLATE
市場皿

0990 5710 - 10cm	¥ 240
0990 5712 - 12	¥ 320
0990 5714 - 14	¥ 410
0990 5716 - 16	¥ 480
0990 5718 - 18	¥ 560
0990 5720 - 20	¥ 680
● HAMMERED	
● ST.ST	



FUNNEL with HOOK
漏斗

0927 0124 - 24 cm	¥ 3,600
● 24φ (cm)	



POTATO MASHER
ポテトマッシャー/ストッパー付

0923 0020 ¥9,550
●24×H10.5 (cm)
●替アミ付
●18-8 ST.ST+ALUMINUM



POTATO MASHER
ポテトマッシャー-ALUMINUM

0923 0010 ¥6,580
●24×H10.5 (cm)
●18-8 ST.ST+ALUMINUM



CREPE SPREADER
クレープトンボ

0924 2000 ¥4,100
●20×25.5 (cm)



CREPE SPREADER
クレープトンボ/U型

0924 2010-17cm ¥4,850
●20 (cm) Handle: 17 (cm)
0924 2015-25 ¥5,000
●20 Handle: 25



GINGER GRATER
おろし器

0995 0510 ¥2,300
●23 (cm)



GRATER/CONE SHAPE
グレーター

0995 0500-8 cm ¥1,050
●4.8 φ × H8 (cm)
0995 0501-11 ¥1,150
●6 φ × H11
0995 0502-16.5 ¥2,000
●7.7 φ × H15
0995 0503-21 ¥2,250
●11 φ × H21
0995 0504-25 ¥2,850
●12.7 φ × H25



SCOOPS/MEASURING CUPS (PC)



ICE SCOOP
アイスコップ/ST

0917 9020-L	¥3,950
●10×H5×28(全長)(cm)	
0917 9021-M	¥3,700
●8×H4×26(全長)	
0917 9022-S	¥2,700
●6×H3×24(全長)	
●18-8 ST.ST	



ICE SCOOP
アイスコップ/クリア

0917 9010-大	¥1,500
●14.5×H10.5(cm) 全長:37	
0917 9011-中	¥1,150
●12.5×H8 全長:33	
0917 9012-小	¥870
●10×H7.5 全長:30	
0917 9013-ミニ	¥780
●8×H5.7 全長:25	
●POLYCARBONATE	



0998 2401

0998 2404

MEASURING CUP
PCメジャーカップ

0998 2400-	250 c.c.	¥720
●8.2φ×H11(cm)		
0998 2401-	500	¥880
●10φ×H13.5		
0998 2402-	1000	¥1,300
●12.5φ×H16.5		
0998 2403-	2000	¥2,450
●15φ×H21		
0998 2404-	3000	¥3,700
●18φ×H23.5		
●POLYCARBONATE		



FOOD STORAGE BASKET
バスケット/角バット仕様/ブラウン

0341 9060	6枚取	¥6,200
●35×49×H9.5(cm)		
0341 9080	8	¥4,200
●30×42×H7		
0341 9100	10	¥3,400
●28×36×H7		
バスケット/角バット仕様/アイボリー		
0341 9061	6枚取	¥6,200
●35×49×H9.5(cm)		
0341 9081	8	¥4,200
●30×42×H7		
0341 9101	10	¥3,400
●28×36×H7		
●PP ラタン 材質:ポリプロピレン		
耐熱温度 120°C		
食器洗浄機対応		
食品衛生法適合		



MEASURING CUP
メジャーカップ/トライアングル

0998 2420-	250 c.c.	¥750
●AS樹脂		
0998 2421-	500	¥950
●PC		
※なくなり次第廃番です。		





CAKE MOULD
チーズケーキ用デコ共底

0924 6015 —浅型 15cm ●15φ×H5.6 (cm)	¥1,350
0924 6018 —浅型 18 ●18φ×H5.6	¥1,550
0924 6021 —浅型 21 ●21φ×H5.6	¥1,800
0924 6118 —深型 18 ●18φ×H7.2	¥1,700
0924 6121 —深型 21 ●21φ×H7.2	¥1,950
0924 6124 —深型 24 ●24φ×H7.2	¥2,350



BOMB MOULD/LEMON
レモン型ボンブ

0915 0201 —30 c.c. ●5.5×4.1×H2.3 (cm)	¥990
0915 0181 —40 ●6.2×4.7×H2.5	¥1,000
0915 0161 —60 ●6.7×5.2×H3	¥1,100



BOMB MOULD/TUBE
チューブ型ボンブ

0913 1611 — 90 c.c. ●5.5φ×H4 (cm)	¥1,200
0913 1621 — 144 ●6.3φ×H4.7	¥1,300
0913 1631 —180 ●7φ×H5	¥1,400



BOMB MOULD/CONE
V型ボンブ

0927 0010 —14 c.c. ●3.4φ×H3 (cm)	¥820
0927 0020 —28 ●3.9φ×H4.3	¥830
0927 0030 —29 ●3.6φ×H5.4	¥830
0927 0040 —43 ●4.2φ×H5.7	¥830
0927 0050 —53 ●4.5φ×H6.5	¥1,100



BOMB MOULD/ROUND
ボンブ型

0912 0011 —10 c.c. ●3.5φ (cm)	¥540	0912 0181 —180 ●9.5φ	¥1,100
0912 0021 —20 ●4.1φ	¥570	0912 0201 —200 ●9.5φ	¥1,210
0912 0031 —30 ●4.9φ	¥600	0912 0251 —250 ●10.5φ	¥1,270
0912 0037 —36 ●5.2φ	¥650	0912 0271 —270 ●10.5φ	¥1,450
0912 0041 —40 ●5.2φ	¥660	0912 0301 —300 ●10.5φ	¥1,490
0912 0051 —50 ●5.4φ	¥690	0912 0351 —350 ●11.5φ	¥1,510
0912 0055 —54 ●5.7φ	¥710	0912 0361 —360 ●11.5φ	¥1,530
0912 0061 —60 ●5.8φ	¥730	0912 0401 —400 ●11.5φ	¥1,670
0912 0071 —70 ●6.5φ	¥770	0912 0501 —500 ●13φ	¥2,050
0912 0081 —80 ●7φ	¥790	0912 0541 —540 ●13.5φ	¥2,180
0912 0091 —90 ●7.4φ	¥810	0912 0551 —550 ●13.5φ	¥2,300
0912 0101 —100 ●7.5φ	¥850	0912 0901 —900 ●15.5φ	¥3,000
0912 0121 —120 ●8φ	¥890	0912 1001 —1,000 ●16φ	¥3,300
0912 0145 —144 ●8.5φ	¥940	0912 1801 —1,800 ●20.5φ	¥5,000
0912 0151 —150 ●8.5φ	¥970	0912 2001 —2,000 ●21φ	¥6,000

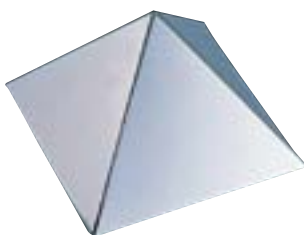

BOMB MOULD/PYRAMID
ピラミッド型ボンブ

0927 0200 —10 c.c. ●4×4×H2.7 (cm)	¥2,050
0927 0201 —50 ●6×6×H4	¥3,100
0927 0202 —90 ●7.5×7.5×H5.2	¥4,250
0927 0203 —160 ●9×9×H6	¥5,550
0927 0204 —390 ●12×12×H8	¥8,150
0927 0205 —770 ●15×15×H10	¥12,700



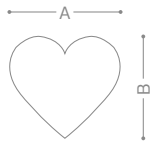

CAKE SETTING RING/HEART
セルクルリング(ケーキリング)ハート

0924 1009 ●A・B/9×8×H3 (cm)	¥4,000
0924 1012 ●A・B/12×10.5×H3	¥4,100
0924 1015 ●A・B/15×13.5×H3	¥4,200
0924 1018 ●A・B/18×16×H3	¥4,300
0924 1021 ●A・B/21×19×H3	¥4,500

※受注生産

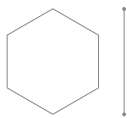

CAKE SETTING RING/HEXAGON
セルクルリング(ケーキリング)六角

0924 1210 ●10×H4 (cm)	¥7,150
0924 1214 ●14×H4	¥8,800
0924 1216 ●16×H4	¥9,350
0924 1218 ●18×H4	¥10,500
0924 1220 ●20×H4	¥13,500
0924 1222 ●22×H4	¥13,500
0924 1224 ●24×H4	¥15,500
0924 1226 ●26×H4	¥18,500
0924 1228 ●28×H4	¥21,500
0924 1230 ●30×H4	¥24,000
0924 1232 ●32×H4	¥27,500

※受注生産



STENCIL/DAHLIA
シャブロン(ダリア)

0924 0014 ●14φ (cm)	¥4,950
0924 0012 ●12φ	¥4,900
0924 0010 ●10φ ●サイズは出来上り寸法です。	¥4,900

※受注生産



STENCIL/MARGUERITE
シャブロン(マーガレット)

0924 0114 ●14φ (cm)	¥4,950
0924 0112 ●12φ	¥4,900
0924 0110 ●10φ ●サイズは出来上り寸法です。	¥4,900

※受注生産



STENCIL/PIVOINE
シャブロン(ピボニス)

0924 0214 ●14φ (cm)	¥4,950
0924 0212 ●12φ	¥4,900
0924 0210 ●10φ ●サイズは出来上り寸法です。	¥4,900

※受注生産



MEASURE SPOON
18-8 極厚 計量スプーン

0998 1400 — 30 c.c. ●17.2 (cm) ●約30 (c.c.)	¥550
0998 1401 — 25 ●16.8 ●約25	¥550
0998 1402 — 20 ●16.4 ●約20	¥460
0998 1403 — 15 ●16.0 ●約15	¥400
0998 1404 — 10 ●15.4 ●約10	¥370
0998 1405 — 5 ●14.6 ●約5	¥370
0998 1406 — 2.5 ●14.0 ●約2.5	¥280
0998 1408 — 1/2 ●11.2 ●約0.5	¥260
0998 1409 — 1/4 ●10.8 ●約0.25	¥260



MEASURING SPOON
メジャースプーン

0924 4010 — 10 c.c. ●3.5φ (cm) Handle: 15.7 (cm) ●1/4 (oz)	¥2,550
0924 4020 — 20 ●4.1φ Handle: 15.7 ●1/2	¥2,650
0924 4030 — 30 ●4.9φ Handle: 15.7 ●1	¥2,650
0924 4036 — 36 ●5.2φ Handle: 15.7 ●1 1/4	¥2,700
0924 4040 — 40 ●5.2φ Handle: 15.7 ●1 1/2	¥2,800
0924 4050 — 50 ●5.4φ Handle: 15.7 ●1 3/4	¥2,900
0924 4054 — 54 ●5.7φ Handle: 15.7 ●1 3/4	¥2,900
0924 4060 — 60 ●5.8φ Handle: 15.7 ●2	¥3,000
0924 4070 — 70 ●6.5φ Handle: 15.7 ●2 1/2	¥3,200
0924 4080 — 80 ●7φ Handle: 15.7 ●2 3/4	¥3,300
0924 4090 — 90 ●7.4φ Handle: 15.7 ●3	¥3,400
0924 4100 — 100 ●7.5φ Handle: 15.7 ●3 1/2	¥3,500
0924 4120 — 120 ●8φ Handle: 15.7 ●4	¥3,600

※受注生産

